

INSTRUCTION MANUAL

Serial Number _____

TYPE 292
SEMICONDUCTOR
TESTER
POWER SUPPLY

Tektronix, Inc.

S.W. Millikan Way • P. O. Box 500 • Beaverton, Oregon • Phone MI 4-0161 • Cables: Tektronix

Tektronix International A.G.

Terrenberg 1A • Zug, Switzerland • PH 042-49192 • Cable: Tekintag, Zug Switzerland • Telex 53.574



WARRANTY

All Tektronix instruments are warranted against defective materials and workmanship for one year. Tektronix transformers, manufactured in our own plant, are warranted for the life of the instrument.

Any questions with respect to the warranty mentioned above should be taken up with your Tektronix Field Engineer.

Tektronix repair and replacement-part service is geared directly to the field, therefore all requests for repairs and replacement parts should be directed to the Tektronix Field Office or Representative in your area. This procedure will assure you the fastest possible service. Please include the instrument Type and Serial number with all requests for parts or service.

Specifications and price change privileges reserved.

Copyright © 1964 by Tektronix, Inc., Beaverton, Oregon. Printed in the United States of America. All rights reserved. Contents of this publication may not be reproduced in any form without permission of the copyright owner.



CONTENTS

	Warranty
Section 1	Characteristics
Section 2	Operating Instructions
Section 3	Circuit Description
Section 4	Maintenance
Section 5	Calibration
Section 6	Parts List and Diagram

A list of abbreviations and symbols used in this manual will be found on page 6-1. Change information, if any, is located at the rear of the manual.



The Type 292 Semiconductor Tester Power Supply

SECTION 1

CHARACTERISTICS

The Type 292 Semiconductor Tester Power Supply furnishes dc power and connection for a sub-nanosecond environment test fixture. The fixture can be wired for measuring time and charge characteristics of diodes and transistors.

The Type 292 is normally used between a sub-nanosecond pulse generator and a 50-ohm input sampling oscilloscope. Certain Tektronix '3' and '4' Series sampling plug-in units will display fast diode and transistor characteristics. Signal connections are made directly to the test fixture through miniature coax cables.

The two variable, electronically regulated power supplies, TEST VOLTS and BIAS CURRENT, are short-circuit and open-circuit protected. Each supply polarity can be inverted from the front panel. Rear mounted terminals allow either supply to be monitored, or for external supplies, to be used with the test fixture.

Test Volts

Fixed dc voltages of 1, 2, 5, 10, and 20 volts. Each within 3% when the VARIABLE control is fully clockwise at CALIB.

The VARIABLE control allows the voltage of each range to be reduced at least a factor of 10:1 of the calibrated value.

Ripple voltage (either polarity) is equal to or less than 4 mv peak-to-peak at any voltage, over a range of 0—200 ma, for line voltages from 105 to 125 or 230 to 250 vac.

Maximum short-circuit current is about 440 ma on all ranges.

Bias Current

Fixture dc currents from 0.1 to 200 ma in 1, 2, 5 sequence. Each within 3% when the VARIABLE control is fully clockwise at CALIB.

The VARIABLE control allows the current of each range to be reduced at least a factor of 10:1 of the calibrated value.

Ripple current (either polarity) listed in Table 1-1 applies for any current from about 2 μ a to 200 ma, for line voltages from 105 to 125 or 230 to 250 vac, providing the load impedance sets the output to be between 0 and 20 volts.

No-load output voltage is about 40 volts.

TABLE 1-1

Bias Current Supply Ripple, Peak-To-Peak

Range	Ripple
0.1—20 ma	$\leq 5 \mu$ a
50 ma	$\leq 10 \mu$ a
100 ma	$\leq 20 \mu$ a
200 ma	$\leq 100 \mu$ a

External Power

External power supplies may be used for other current or voltage values than supplied internally. Leads from the external jacks to the test fixture limit externally supplied current to 1 ampere.

Power Requirements

117 or 234 volts ac, 50 to 60 cycles.

Maximum power is approximately 30 watts at 60 cycles.

Ventilation

The Type 292 circuits are completely enclosed. Heat dissipation is by radiation and convection. Maximum ambient operating temperature is 50°C.

Construction

Mechanical—Aluminum-alloy cabinet and test fixture platform.

Finish—Photo-etched anodized panel; grey bottom plate; blue wrap-around case and platform.

Dimensions—Height 4⁵/₈ inches; width 8 inches including handle; depth 10 inches.

Weight—6 pounds 5 ounces.

Accessories Included

	Tektronix Part No.
1—Transistor Test Fixture, unwired, with connecting plugs and transistor socket	016-057
3—P6040 Cables, 50 Ω , with GR Type 874 Connectors on one end and miniature connectors on other end to mate with test fixture jacks	175-269
1—Three-wire power cord	161-015
1—Three-wire to two-wire power cord adapter	103-013
2—Instruction manuals	070-410

Optional Accessories

Transistor Test Fixture, Grounded Base	016-058
Diode Test Jig. Fits on Diode Test Jig Adapter	013-080
Diode Test Jig Adapter	016-059

SECTION 2

OPERATING INSTRUCTIONS

PRELIMINARY INSTRUCTIONS

Power Requirements

There are two primary windings in the power transformer. One winding has its terminals marked 1 and 3; the other marked 2 and 4. For 117-volt operation, the two windings are connected in parallel by wiring terminal 1 to 2 and terminal 3 to 4. For 234-volt operation, the two primary windings are connected in series by wiring terminal 2 to 3. For both 117- and 234-volt operation, one ac power input lead is connected to terminal 1 and the other to terminal 4.

A label right above the power receptacle indicates the voltage for which the unit was wired at the factory.

Fuse Requirements

Use a 0.3-amp slow blowing type fuse if the Type 292 is wired for 117-volt operation, or a 0.15-amp slow-blowing type fuse for 234-volt operation.

First Time Operation

Assume the need for 5 volts from the Test Volts supply and 10 ma from the Bias Current Supply.

1. Set the Type 292 controls:

Right TEST VOLTS	5
Center TEST VOLTS	OFF
Center BIAS CURRENT	OFF
Left BIAS CURRENT	10
VARIABLE (both)	Fully clockwise
2. Connect the power cord to the correct value power line (as labeled on back panel next to power cord socket).
3. Insert the leads of a voltmeter into the test platform TEST VOLTS banana jacks, negative lead to the ground jacks, positive lead to the NPN+/PNP- jack.
4. Set the center TEST VOLTS switch to NPN. The meter will indicate +5 volts.
5. Rotate the right Test Volts VARIABLE control slowly counterclockwise and the meter will slowly follow to zero volts.
6. Move the meter leads to the BIAS CURRENT banana jacks, negative lead to the unlabeled jack, positive lead to the +NORMAL/-INVERTED jack. There will be no reading. Switch the meter to read the current of 10 ma.
7. Set the center BIAS CURRENT switch to NORMAL. The meter will indicate a 10-ma current.
8. Rotate the left Bias Current VARIABLE control slowly counterclockwise and the meter will slowly follow to nearly zero current.

9. Remove the meter leads. Set both center switches to OFF. Reset both VARIABLE controls fully clockwise. The instrument is ready to be used with any test fixture.

The uses of the Type 292 can be partially explored by reading the following information on transistor testing, switching diode, and signal probes.

TRANSISTOR SWITCHING

The switching characteristics of a fast-switching transistor can be measured by connecting the transistor into a grounded-emitter circuit. Then the transistor is switched on and off by a fast-rise pulse applied to its base. Comparing the applied pulse with the resultant collector output signal provides a method for measuring the switching characteristics of the transistor.

The fast-rise switching pulse is obtained from an external generator and the comparison of the switching pulse and collector signals is made on an oscilloscope. Both the pulse generator and the oscilloscope are dc-coupled to the grounded-emitter circuit on the test fixture. This permits transistor collector voltage levels to be observed on the oscilloscope.

Grounded-Emitter Test Circuit

Components in the grounded-emitter test circuit and applied voltages determine the potentials applied to the transistor. Fig. 2-1 is a simplified schematic of a grounded-emitter test circuit used with the Type 292.

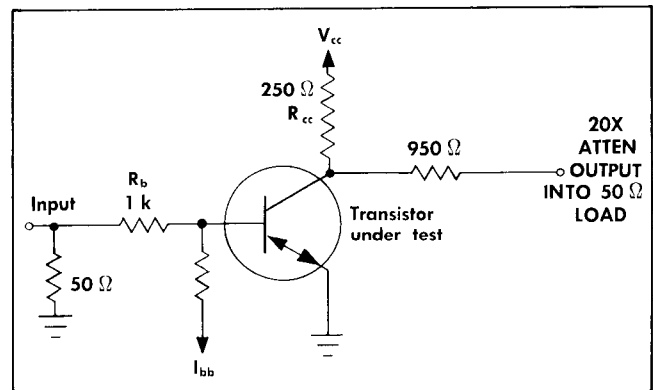

Fig 2-1. Simplified schematic of a grounded-emitter test circuit.

When the fast-rise input pulse saturates the transistor, the base is near ground potential. Transistor dc-bias current is determined by the BIAS CURRENT supply. This current flows to the nearly grounded base of the transistor during saturation. The input signal current is determined by the input voltage drop across the 1 k base resistor. Depending on voltage polarities, the input current either overcomes or adds to the bias current.

Operating Instructions—Type 292

The collector voltage is determined by the current through the 250 Ω collector-load resistor and the TEST VOLTS supply voltage (V_{cc}). The output voltage at the collector is attenuated by the 950 Ω attenuation resistance and the 50 Ω oscilloscope termination resistance. The input signal sees a 50 Ω termination resistance at the input. Construction techniques for building your own test fixtures are discussed later in this section.

Test System Risetime

Risetime of the test system limits the minimum transistor risetime that can be accurately measured.

To make accurate measurement (on the oscilloscope crt display) of a fast pulse risetime, consider the following:

1. The oscilloscope crt alignment must be correct so that a free-running sweep is parallel to a horizontal graticule line.
2. The Timing Unit must be correctly calibrated. This can be checked quickly by inserting a 30-cm air line (1-nsec delay) in series with the external triggering-signal cable and noting the trace shift. See the Timing Unit instruction manual for more details.
3. The signal source impedance must be low.
4. If using a sampling oscilloscope when the signal repetition rate is low, and if you use a small number of samples/cm, the dot transient response must be checked and the smoothing control correctly adjusted.
5. Calculate the signal true risetime from the following:

If the pulse signal is transported to the oscilloscope through a short section of coaxial cable, and if the cable is as large as RG-8/AU exhibiting essentially no high-frequency attenuation in the form of "dripple-up", the pulse-display risetime T_r is:

$$T_r = \sqrt{(\text{Signal } T_r)^2 + (\text{Scope } T_r)^2}$$

Transposing:

$$\text{Signal } T_r = \sqrt{T_r^2 - (\text{Scope } T_r)^2}$$

Voltage Pickoff In Terminated Coaxial Line

The Tektronix P6038 Direct Sampling Probe can be used with a Type 661/4S3/5T1A to look at the voltage signal in a terminated 50 Ω coaxial line by using the Tektronix VP-2. The VP-2 is a specially designed Tee adapter that causes very little reflection in a closed coaxial system. (An ordinary coaxial Tee causes much more reflection.) The VP-2 provides a 50 Ω source impedance to the P6038 Probe (there is 25 Ω in series with the tip inside the VP-2). Its use allows the probe to observe signals on the coaxial center conductor with essentially no effect upon the information on its way to its normal load. Use of the VP-2 will degrade the signal risetime slightly.

Pulse Generator Requirements

The switching pulse from the fast-rise pulse generator must have enough amplitude and duration to drive the transistor under test into saturation for a short time. The pulse polarity must be positive for NPN transistors and negative for PNP.

Transistor Voltage Requirements

The collector and base voltage ratings of the transistor under test should never be exceeded. Also, make sure the tester supply switches are in the correct polarity for the type of transistor under test.

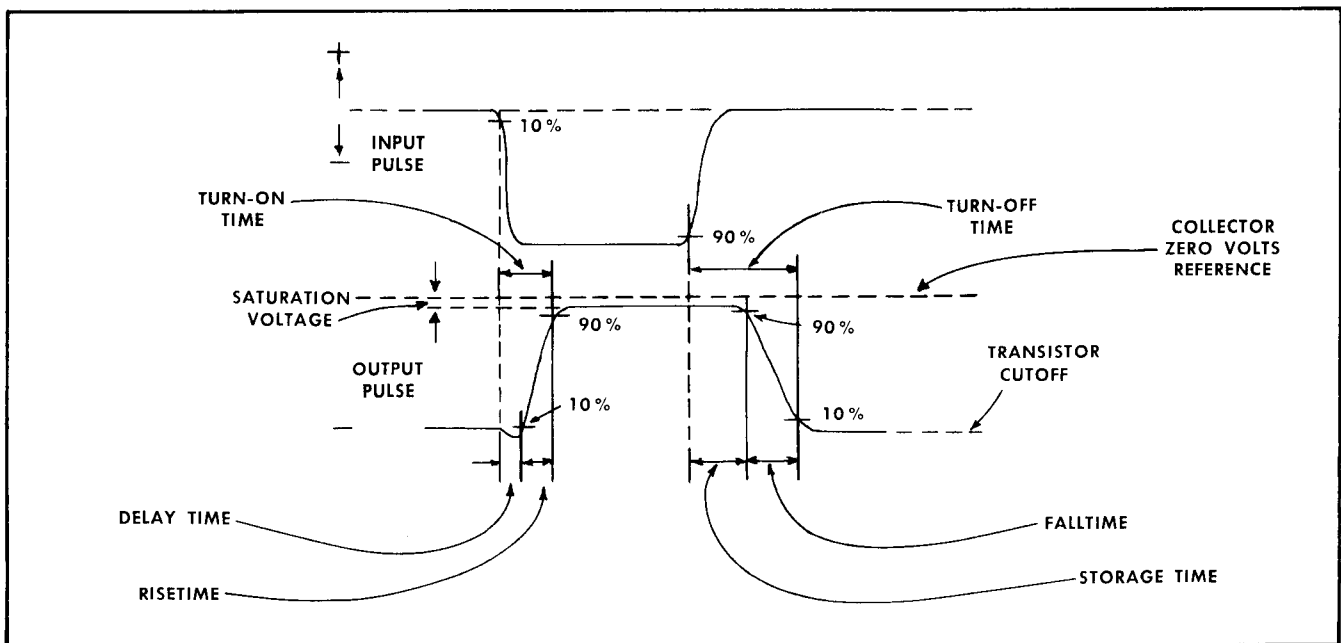

Fig. 2-2. Transistor switching characteristics.

Transistor Switching Terms (See Fig. 2-2)

Delay Time: The time interval between the 10% levels on the leading edge of the input and output pulses.

Risetime: The time interval between the 10% level and 90% level on the leading edge of the output pulse.

Turn-On Time: The time interval between the 10% level on the leading edge of the input pulse and the 90% level on the leading edge of the output pulse. Turn-on time is the sum of the delay time and risetime.

Storage Time: The time between 90% levels on the trailing edge of the input and output pulses.

Falltime: The time interval between the 90% and 10% levels on the trailing edge of the output pulse.

Turn-Off Time: The time interval between the 90% level on the trailing edge of the input pulse and the 10% level on the trailing edge of the output pulse. The turn-off time is the sum of the storage time and fall time.

Saturation Voltage: The voltage difference between transistor collector voltage at saturation and zero collector voltage.

Calculating I_{b1} and I_{b2}

I_{b1} is determined by the formula:

$$I_{b1} = \frac{E_{gen} - V_{eb}}{R_b} - I_{b2}$$

where E_{gen} is the amplitude of the input pulse, V_{eb} is the emitter-base voltage when forward biased, and R_b is the series resistance in the base lead. (Often V_{eb} is neglected when calculating I_{b1} and I_{b2} .) I_{b2} is closely approximated by the formula:

$$I_{b2} \cong I_{bb} + \frac{V_{eb}}{R_b}$$

where I_{bb} is the external base current supply (Type 292 BIAS CURRENT supply setting), and V_{eb}/R_b is the short term base-

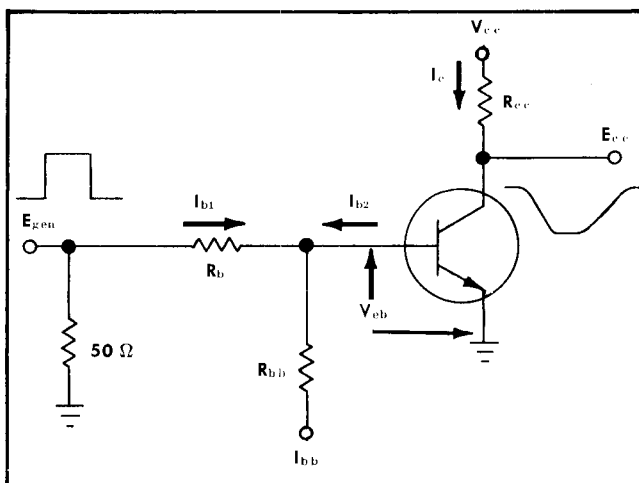

Fig. 2-3. Terms used when switch testing transistors.

emitter depletion-layer stored charge removal at the time the turn-on signal ends. Fig. 2-3 illustrates I_{b1} and I_{b2} . If I_{bb} is turned off, then:

$$I_{b2} = \frac{V_{eb}}{R_b}$$

Calculating Forced-Circuit Beta

The grounded-emitter circuit of Fig. 2-3 is sometimes referred to as a forced-circuit; that is, when testing a high-beta transistor, the indicated beta of the transistor is limited to the forced-circuit beta of the tester. A transistor having a beta lower than the forced-circuit beta of the tester cannot be tested under forced-circuit conditions and thus will not reach saturation and may have a slow risetime.

Maximum beta of the circuit is determined by the ratio of the base resistances to collector resistances and the amplitude of input pulses and the values of I_b and V_{cc} applied. In Fig. 2-3, the resistances are fixed so only the input, base current, and collector voltages can vary the forced-circuit beta. Forced-circuit beta of the tester is determined by comparing the collector current to the base current produced by the input pulse. The forced-circuit beta formula for Fig. 2-3, is derived by starting with:

$$\beta_{fc} = \frac{I_c}{I_{b1}}$$

where β_{fc} is the forced-circuit beta, I_c is collector current, and I_{b1} is base signal current.

The collector current (transistor saturated) is determined by the formula:

$$I_c = \frac{V_{cc}}{R_{cc}}$$

where V_{cc} is the collector supply voltage and R_{cc} is the collector load resistance.

The base current is determined by the formula:

$$I_{b1} = \frac{E_{gen} - V_{eb}}{R_b} - I_{b2}$$

as previously stated. Combining terms:

$$\beta_{fc} = \frac{I_c}{I_{b1}} = \frac{V_{cc}}{R_{cc}} \div \frac{(E_{gen} - V_{eb}) - I_{b2}}{R_b}$$

Values for V_{cc} and I_{bb} are obtained from the Type 292 control settings. E_{gen} is the pulse generator output voltage when terminated at the test fixture input.

CAUTION

V_{cc} should not exceed transistor collector voltage rating. Otherwise, the transistor may be damaged when E_{gen} is zero.

BASIC TEST SYSTEMS

There are several test systems that can be assembled using the Type 292 with various combinations of fast-rise pulse generators and oscilloscopes. However, only four basic systems are described in the following discussions. If your

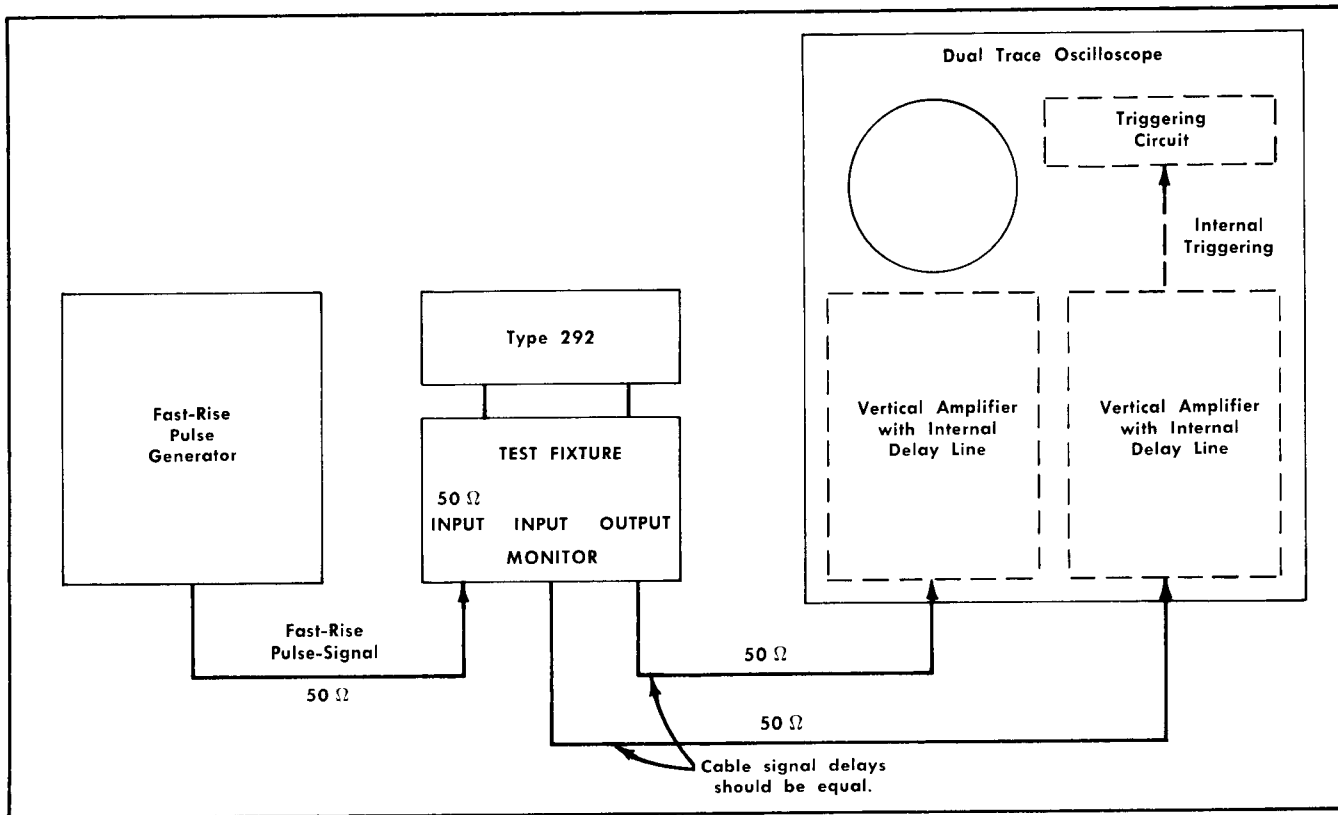

Fig. 2-4. Block diagram of Test System One.

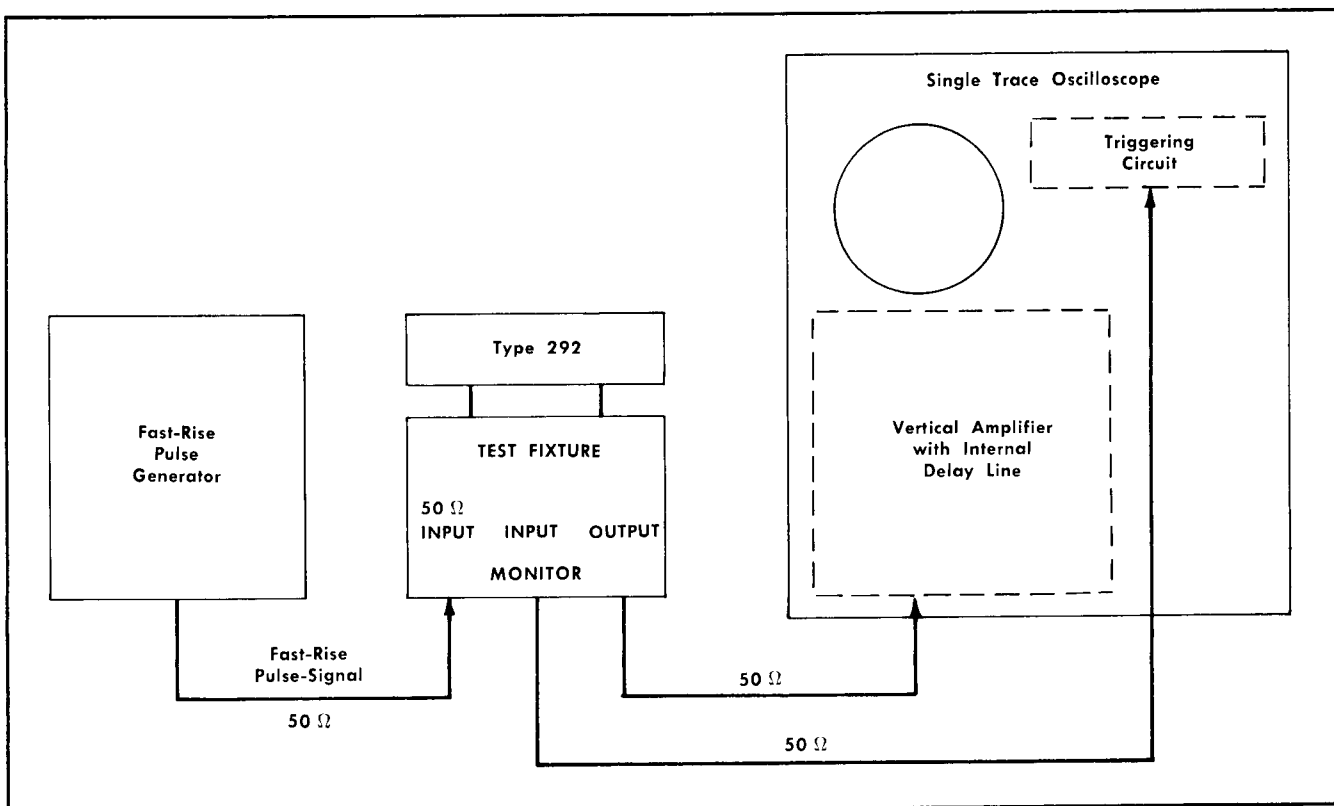

Fig. 2-5. Block diagram of Test System Two.

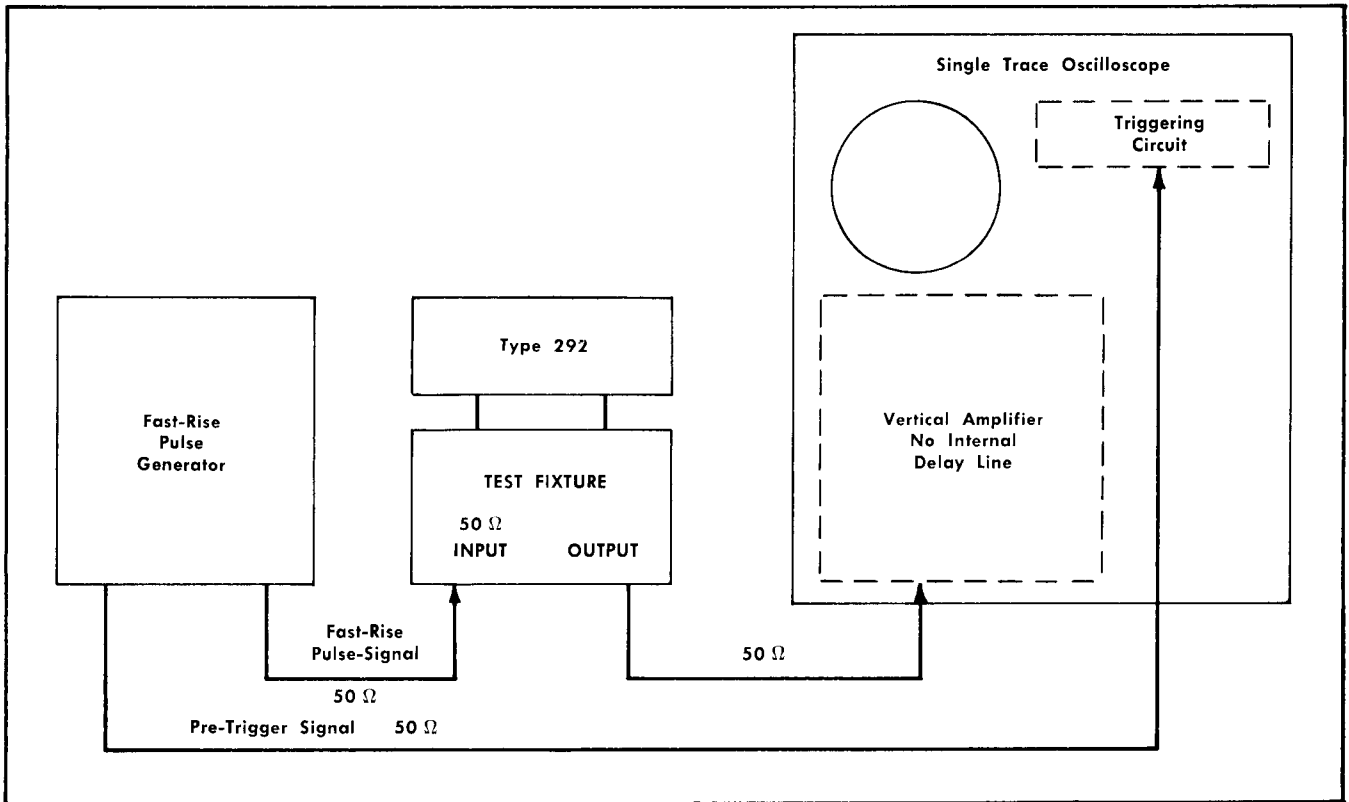

Fig. 2-6. Block diagram of System Three.

test equipment does not fit one of the basic test systems described, see if using parts of more than one system will make a useable combination.

Regardless of the generator and oscilloscope used, each instrument should be operated according to its individual instruction manual.

The entire test system should be dc-coupled. Attenuators may have to be used to maintain dc-coupling by reducing signals to useable levels. Also, the risetime of the test system limits the fastest transistor risetime that can be accurately measured.

Test System One

Test system one uses a dual-trace oscilloscope with internal vertical-signal delay, and any fast-rise pulse generator. Fig. 2-4 shows the test setup. This system simultaneously displays the transistor base input signal on one trace and the collector output signal on the other trace. Transistor switching characteristics are determined by comparing the two signals. (This is a block diagram using the circuit of Fig. 2-1 and/or Fig. 2-15.)

The signal path from the generator to the display is different for each trace. Thus, transit time for one signal may be longer than for the other. Differences in transit time must be considered when measuring transistor switching characteristics. To determine the time difference, compare the two fast-rise generator pulses displayed when a very

short wire is placed in the transistor socket collector and base terminals. Reduce signal transit times by using cables of equal delay. Interchanging the cables may help reduce differences in signal transit time.

Test System Two

Test system two uses a single-trace oscilloscope with internal vertical-signal delay and any fast-rise pulse generator. Fig. 2-5 shows the test setup. This system displays the transistor base input signal. Exchanging the cable positions on the test fixture displays the transistor collector output signal. Transistor switching characteristics are determined by comparing the two signals.

Test System Three

Test system three uses a single-trace oscilloscope without internal vertical-signal delay and a pulse generator without a pretrigger output. Fig. 2-6 shows the test setup. This system operates the same as test system two.

Test System Four

Test system four uses a single-trace oscilloscope without internal vertical-delay, a fast-rise pulse generator without a pretrigger output, and an external delay line. Fig. 2-7 shows the test setup. This system operates the same as test system two.

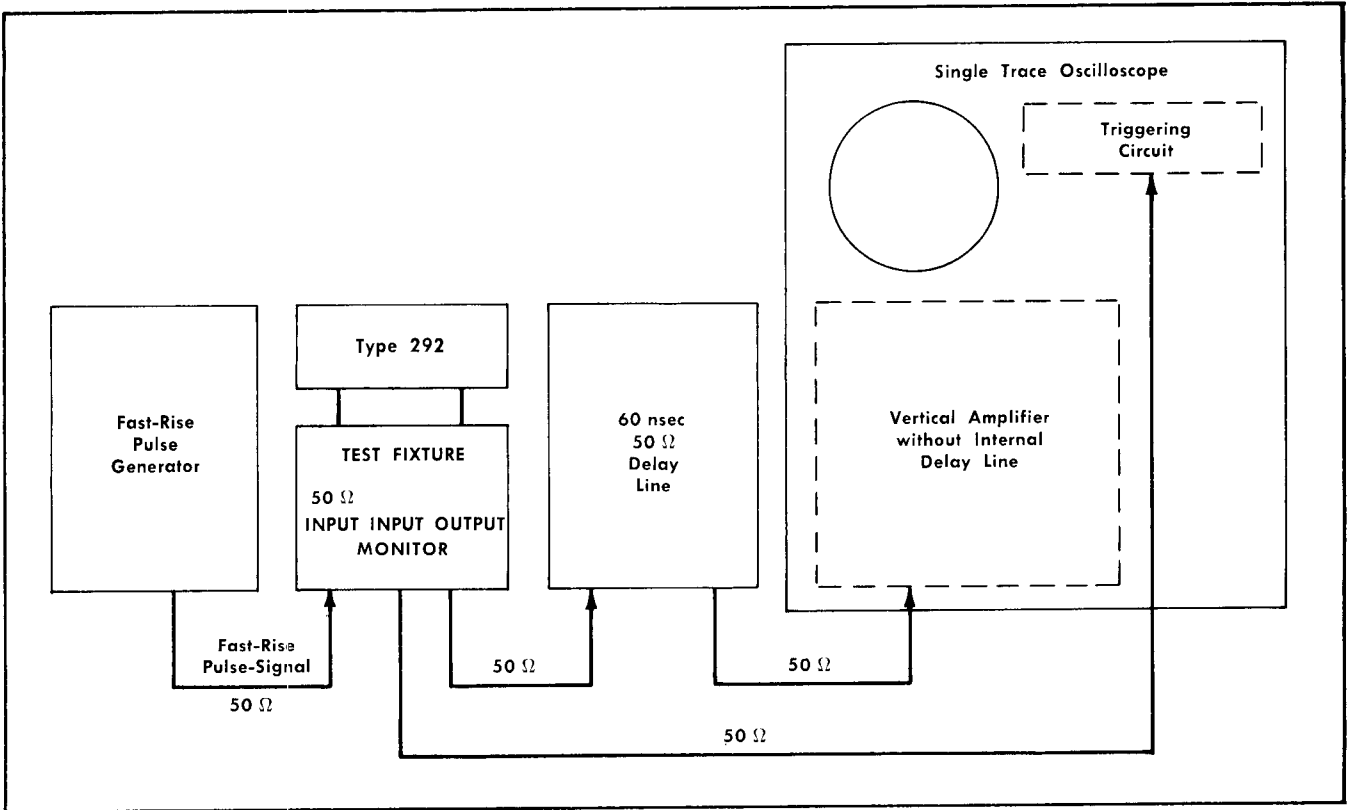

Fig. 2-7. Block diagram of Test System Four.

TRANSISTOR MEASURING TECHNIQUES

The following information provides techniques for measuring switching characteristics of fast-switching transistors. The switching characteristics are displayed when the transistor is switched into saturation from cutoff. Thus, saturation voltage, turn-on characteristics, and turn-off characteristics can be observed and measured.

The steps in the following procedures are for single-trace test systems. Most steps are identical for dual-trace test systems and those that are not identical have additional information at the end of the step.

Saturation Voltage

To obtain an oscilloscope display for measuring transistor saturation voltage, use the following procedure:

1. Set the pulse generator output voltage, and the Type 292 TEST VOLTS supply and BIAS CURRENT supply, to their proper values. Make proper connections to the oscilloscope. Turn both the pulse generator and the Type 292 off.
2. Obtain a free-running sweep on the oscilloscope, and vertically position the trace to a convenient graticule line. This establishes the zero collector-volts reference line; therefore, do not adjust the vertical position control during the remainder of this procedure. (For dual-trace test systems, display only the one signal from the test fixture collector connector for the entire procedure. See Fig. 2-14.)

3. Insert the transistor into the test socket.
4. Turn the pulse generator on. Set the Type 292 center TEST VOLTS switch to NPN or PNP, the center BIAS CURRENT switch to NORMAL or INVERTED (depending on type of transistor under test), and set the oscilloscope triggering controls for a display similar to that shown in Fig. 2-8. Use this display to measure saturation voltage of the transistor.

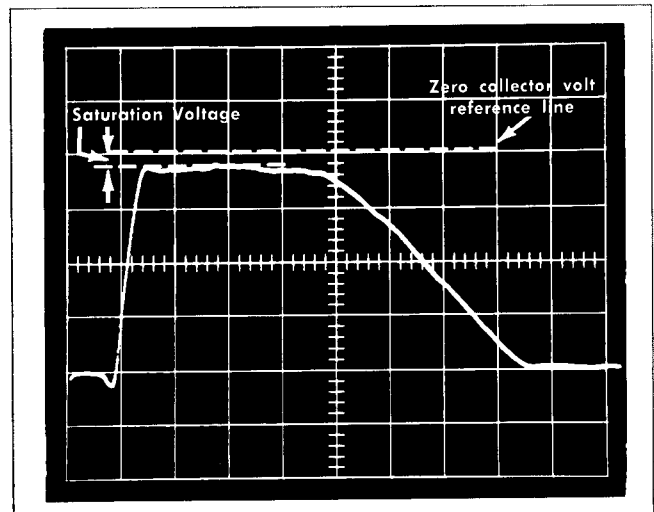

Fig. 2-8. Oscilloscope display used to measure saturation voltage.

NOTE

Any number of transistors with the same specifications can be measured by repeating steps 3 and 4.

Turn-On Characteristics

To obtain an oscilloscope display for measuring transistor turn-on characteristics (delay time, risetime, and turn-on time), use the following procedure:

1. Set the pulse generator output voltage, and the Type 292 TEST VOLTS supply and BIAS CURRENT supply, to their proper values. Make proper connections to the oscilloscope. Turn both the pulse generator and the Type 292 off.
2. Turn the pulse generator on and set the oscilloscope controls for a display similar to that shown in Fig. 2-9 at the test fixture monitor jack (Fig. 2-14).

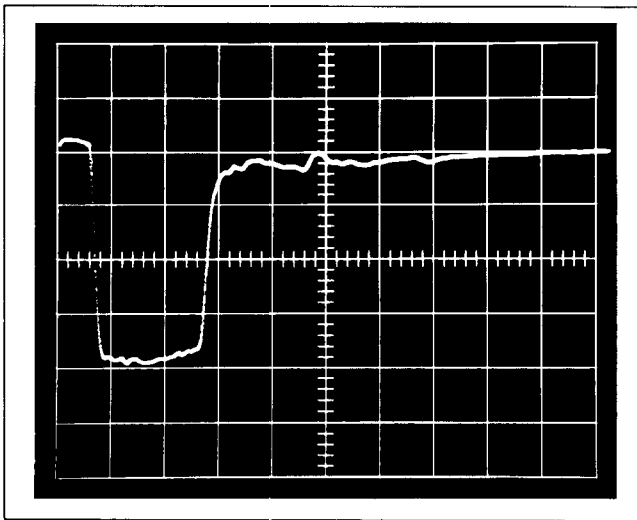

Fig. 2-9. The switching pulse applied to the transistor base.

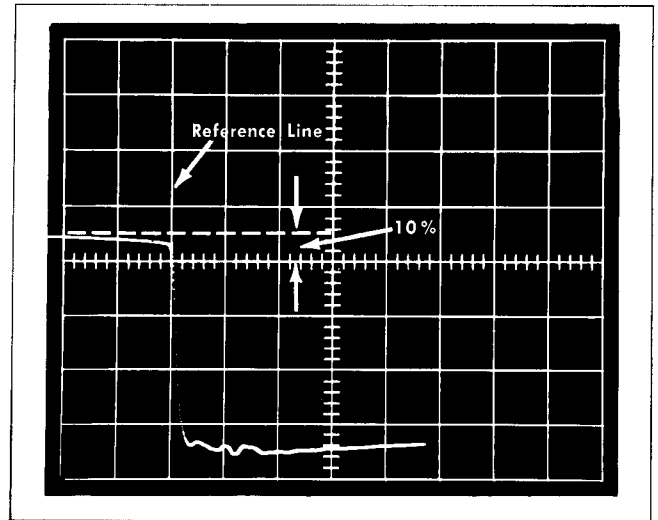

Fig. 2-10. Establishing the turn-on reference line from the 10% level of the switching-pulse leading edge.

NOTE

Any number of transistors with the same specifications can be measured by repeating steps 5 and 6.

Turn-Off Characteristics

To obtain an oscilloscope display for measuring transistor turn-off characteristics (storage time and falltime), use the following procedure:

1. Set the pulse generator output voltage, and the Type 292 TEST VOLTS supply and BIAS CURRENT supply, to their proper values. Make proper connections to the oscilloscope. Turn both the pulse generator and the Type 292 off.
2. Turn the pulse generator on and set the oscilloscope controls for a display similar to that shown in Fig. 2-9.

3. Readjust the oscilloscope sweep rate to display the switching-pulse leading edge as shown in Fig. 2-10. Horizontally position the display so the 10% level coincides with a convenient vertical graticule line. This establishes the turn-on reference line; therefore, do not adjust the horizontal position control during the remainder of this procedure.
4. Turn the pulse generator off. Connect the oscilloscope input to the test fixture collector connector.
5. Insert the transistor into the test socket.
6. Turn the pulse generator on. Set the Type 292 center TEST VOLTS switch to NPN or PNP, center BIAS CURRENT switch to NORMAL or INVERTED (depending on type of transistor under test), and set the oscilloscope control for a display of the collector output signal leading edge similar to that shown in Fig. 2-11. Use this display to measure transistor turn-on characteristics. (For dual-trace test systems, use the signal connectors as in Fig. 2-4 to obtain the displays.)

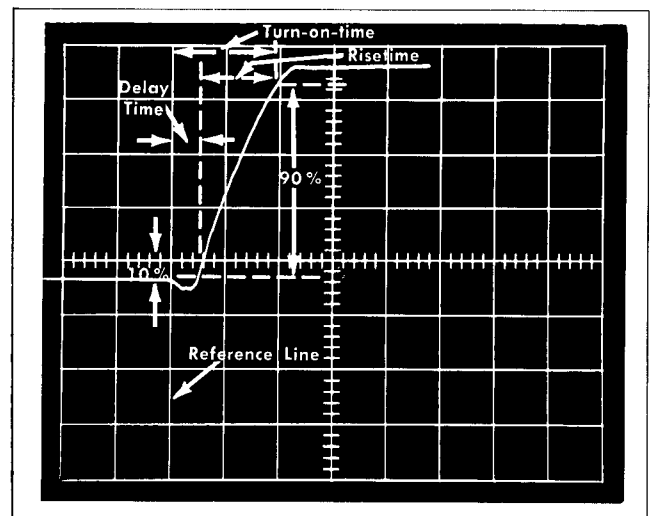

Fig. 2-11. Measuring transistor turn-on characteristics from the leading edge of the collector output signal.

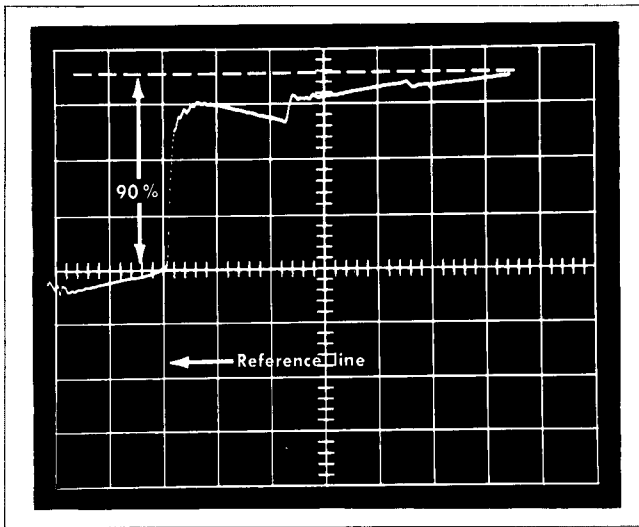

Fig. 2-12. Establishing the turn-off reference line from the 90% level of the switching-pulse trailing edge.

3. Readjust the oscilloscope sweep rate to display the switching-pulse trailing edge as shown in Fig. 2-12. Horizontally position the display so the 90% level coincides with a convenient vertical graticule line. This establishes the turn-off reference line; therefore, do not change the horizontal position of the display during the rest of this procedure.
4. Turn the pulse generator off.
5. Insert the transistor into the socket.
6. Turn the pulse generator on, the Type 292 center TEST VOLTS switch to NPN or PNP, the center BIAS CURRENT switch to NORMAL or INVERTED (depending on type of transistor under test), and set the oscilloscope controls for the collector output trailing-edge display similar to that shown in Fig. 2-13. Use this display to measure the transistor turn-off characteristics. (For dual-trace test

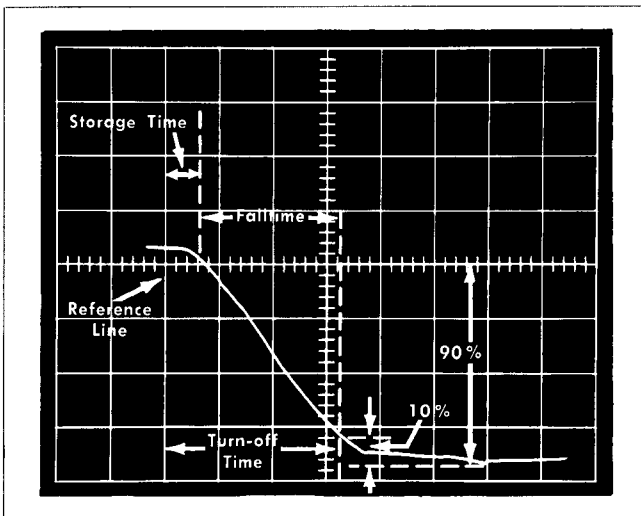

Fig. 2-13. Measuring transistor turn-off characteristics from the trailing edge of the collector output signal.

systems, use the signal connectors as in Fig. 2-4 to obtain the display.)

NOTE

Any number of transistors with the same specifications can be measured by repeating steps 5 and 6.

Class A Operation

The Type 292 can be used to measure the risetime of transistors used as Class A amplifiers.

To test a class A amplifier transistor, it should be biased in a "turn-on" condition (not cutoff), and the fast-rise input pulse should be small to keep from driving the transistor into saturation.

Set the turn-on Bias Current by using the Bias Current VARIABLE control while observing the collector voltage from the dc-coupled oscilloscope display.

Care must be taken on how much "turn-on" bias is used because it is possible to have excessive base current and/or emitter-to-collector current that can damage the transistor. To determine the maximum "turn-on" bias current that may be applied without transistor damage, use the following equation:

$$I_{bb \text{ max}} = \frac{P_{\text{max}}}{\beta V_{ce}}$$

where $I_{bb \text{ max}}$ is maximum allowable base current, P_{max} is the maximum collector dissipation at the given conditions of the transistor, V_{ce} is the actual collector-emitter voltage under operating conditions, and β is the current gain of the transistor (beta).

Test Fixture Construction

Figs. 2-14, 2-15, and 2-16 show the test fixture (shipped with Type 292) wired for grounded-emitter circuit transistor testing. Items of special note for construction techniques are as follows.

1. All resistors are standard 1/4-watt, 1% Mil-Bel with the exception of the special base input resistor R_b and the 1/8-watt 110 Ω input resistors.
2. R_b must be a thin body, long resistor, such as the Texas Instrument 1/4-watt, 1 k, 1% deposited carbon resistor shown.
3. Use short leads for all connections.
4. The two radial lead capacitors, one at the Monitor Output and one at the Collector Output jack, are coaxially assembled. They are NPO type with the output lead of the attenuator resistor(s) run through the capacitor body to approximate a 50 Ω environment beginning at the resistor end.
5. The "hairpin" capacitor at the 950 Ω collector output resistor is part of a frequency-compensated voltage divider into the output 50 Ω line. Locate the hairpin leads as close as possible to the resistor, and cut their length to give the best pulse response. Calibration of the output compensation is accomplished by injecting the pulse generator signal into the transistor socket collector and emitter

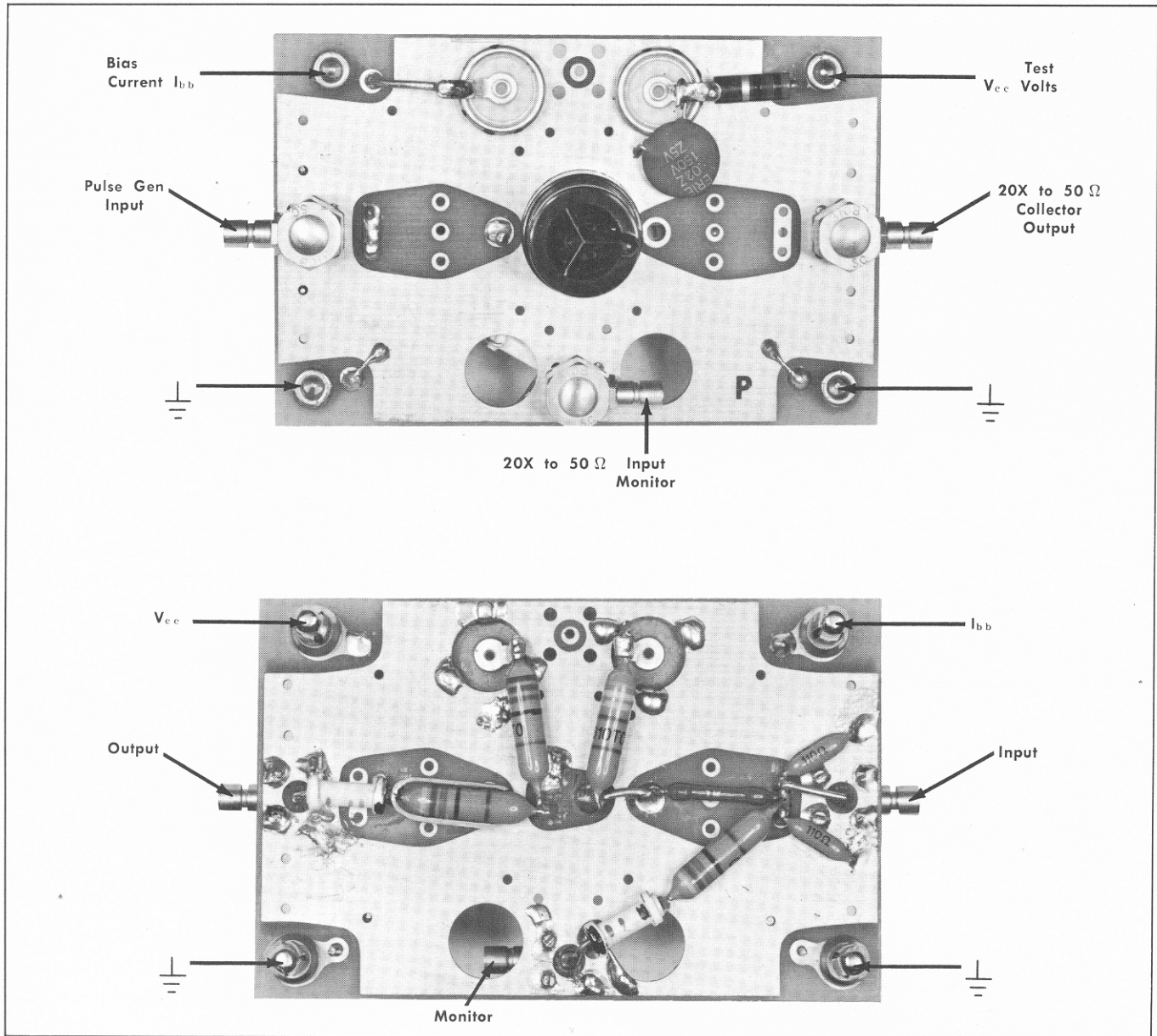

Fig. 2-14. Test fixture wired as grounded-emitter test circuit diagramed in Figs. 2-15 and 2-16.

terminals. Use the signal injection probe shown in Fig. 2-17. Observe the attenuated Collector Output jack signal with the 50 Ω sampling oscilloscope.

Adjustment of the hairpin capacitor is adequate when a small amount of ringing is evident for about 2 nsec after the 100% point of the output pulse. This is better than the case of more hairpin capacitance for fast rise and less ringing, because most known transistors output signal requires 2 nsec or longer to reach the 100% pulse point after the input pulse reaches 100%.

Other Signal Coupling Considerations

A number of items must be considered when constructing built-in signal probes. Both internal and external characteristics affect their operation. A probe is built to transfer

energy from a source to a load, with controlled fidelity and attenuation. It must be equally responsive to all frequencies within the limits of the system, be able to carry a given energy level, and be mechanically adaptable to the measured circuit. The use of 1/4-watt and 1/8-watt resistors is advantageous in the construction of signal-coupling circuits since their small size aids in obtaining good high-frequency response. The probe must not load the circuit heavily or the display may not present a true representation of the circuit operation. Heavy loading may even disrupt the operation of the circuit. A base-band nature (dc to some upper frequency) is not required of all probes, as some needs lie only within a specific bandpass.

The only probes considered here will be signal-monitoring probes, since signal-injecting probes apply more appropriately to the operation of signal generators.

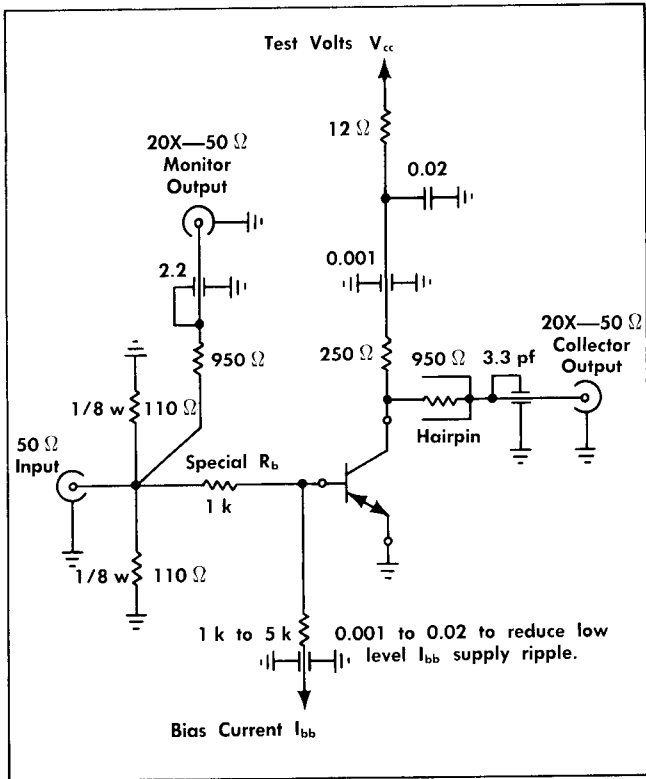

Fig. 2-15. Diagram of special grounded-emitter test fixture shown in Fig. 2-14.

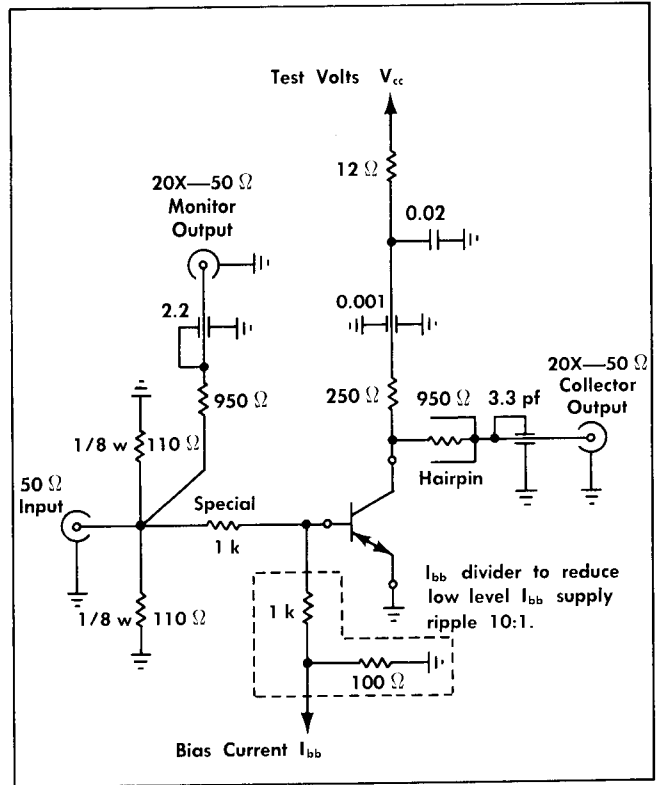

Fig. 2-16. Alternate Bias Current supply decoupling of special test fixture of Fig. 2-14.

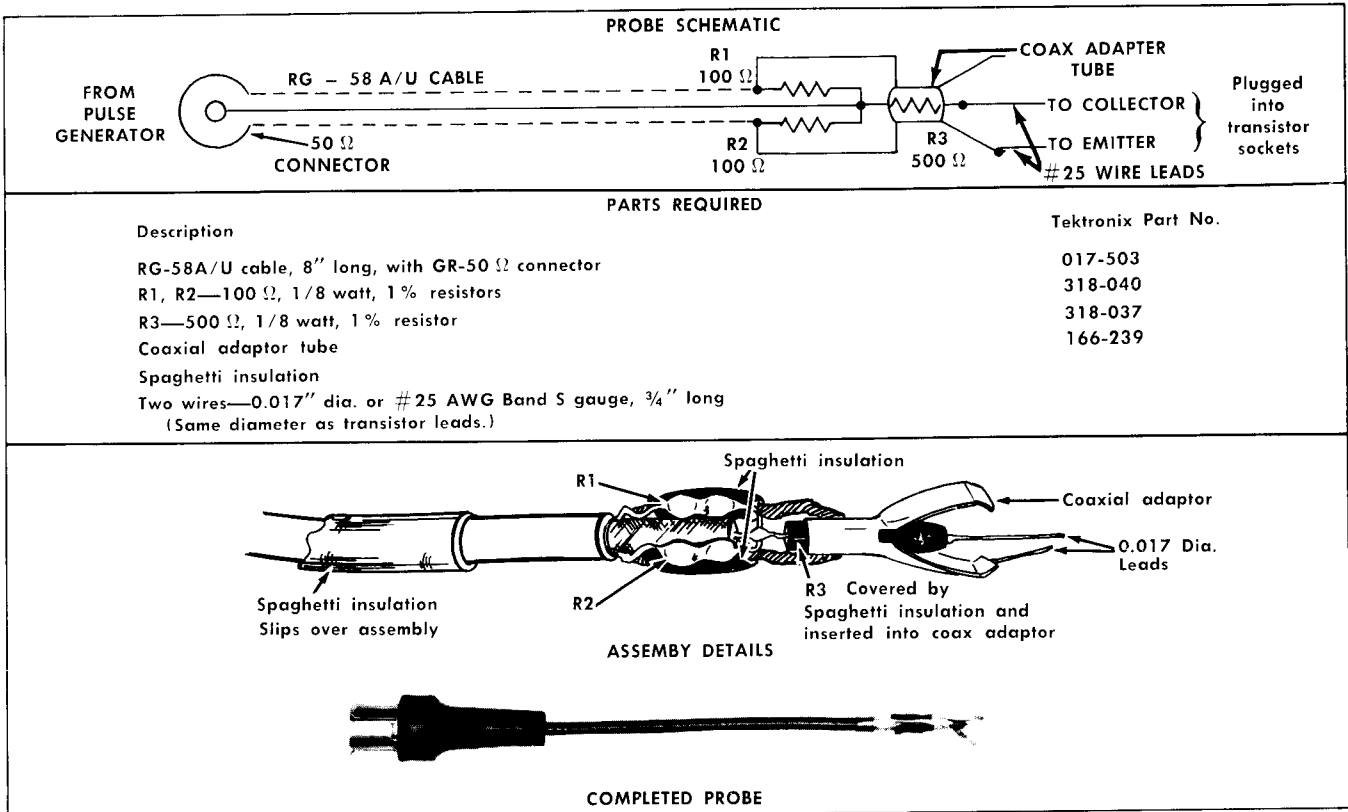
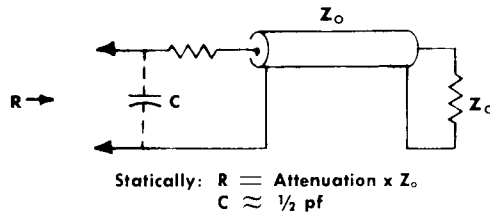

Fig. 2-17. Signal-injection probe construction.

I. PASSIVE

A. TERMINATED CABLE

1. Single Termination



Low static R, good high speed response.

Example: P6035 Probe
 $Z_o = 50 \Omega$ $R = 5 \text{ k}$
 Attenuation = 100X

2. Double Termination

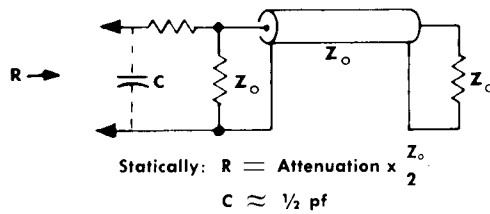

Low static R, good high speed response.
 Double termination reduces reflections.

Example: P6026 Probe
 $Z_o = 50 \Omega$ $R = 500 \Omega$
 Attenuation = 20X

B. NON-TERMINATED CABLE

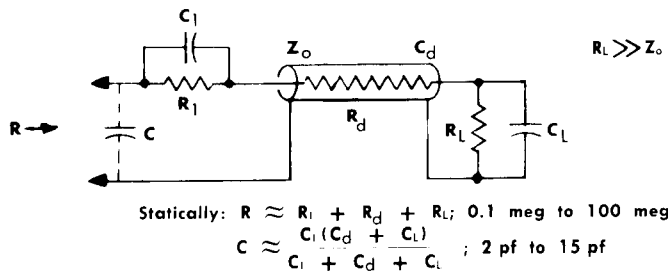

High static R, limited high speed response.

II. ACTIVE

A. DIRECT SAMPLING

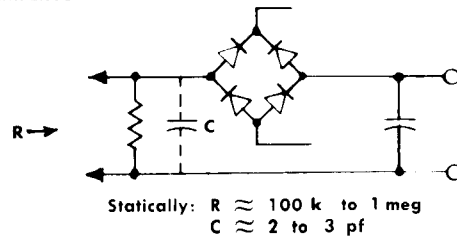

High static R.
 Kickback disturbs display baseline.
 Most sensitive system.

Example: P6038 Probe

B. CATHODE FOLLOWER

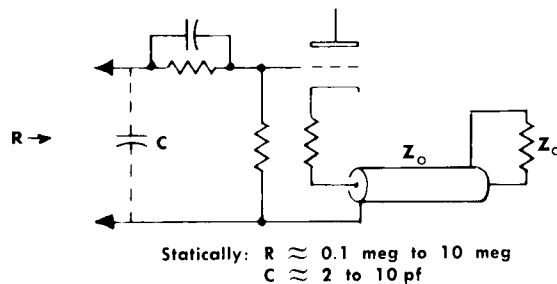

High static R; poor dynamic range.
 Drives delay cable.

Example: P6032 Probe

Fig. 2-18. Types of "non-loading" voltage-sensing probes.

Operating Instructions—Type 292

Voltage-sensing, "non-loading" probes can be grouped into the four basic categories shown in Fig. 2-18. Since a removable probe must be designed with the same electrical parameters as a built-in probe, no distinction will be made between the two. Single and double terminated passive probes (Types 1.A.1. and 1.A.2. of Fig. 2-18) are of primary interest because of the good high-speed response. Small passive probes (Type 1.A.1. of Fig. 2-18) are available with risetimes of 100 picoseconds and 200 picoseconds, such as built into the test fixture of Fig. 2-14.

Major limiting factors, when building attenuator probes, are the resistor characteristics at fractional nanosecond speeds. Fig. 2-19 shows the equivalent circuit of a deposited carbon resistor with normal axial leads. Because of these equivalent circuit characteristics, frequency compensation of the terminated cable probe of Fig. 2-18(1.A) requires the special construction techniques shown in Fig. 2-20. The probe built into the test fixture of Fig. 2-14 is accurately represented by Fig. 2-20 (3).

The static input resistance of signal probes is measurable with an ohmmeter. But at high frequencies, the input resistance drops to a value equal to either the transient damping resistance or the resistance of the termination. The drop

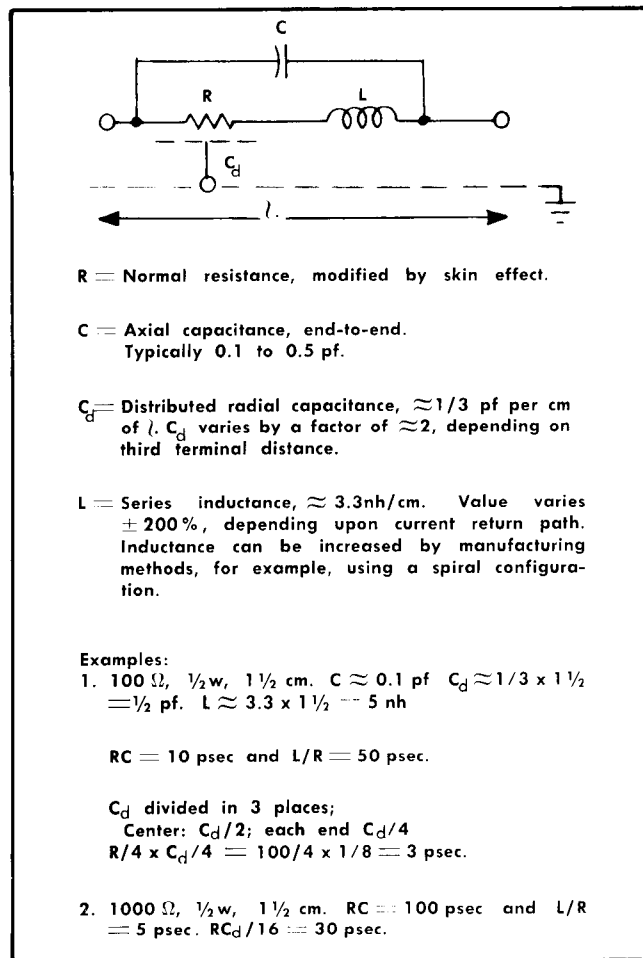

Fig. 2-19. Equivalent circuit and environment of a deposited carbon resistor.

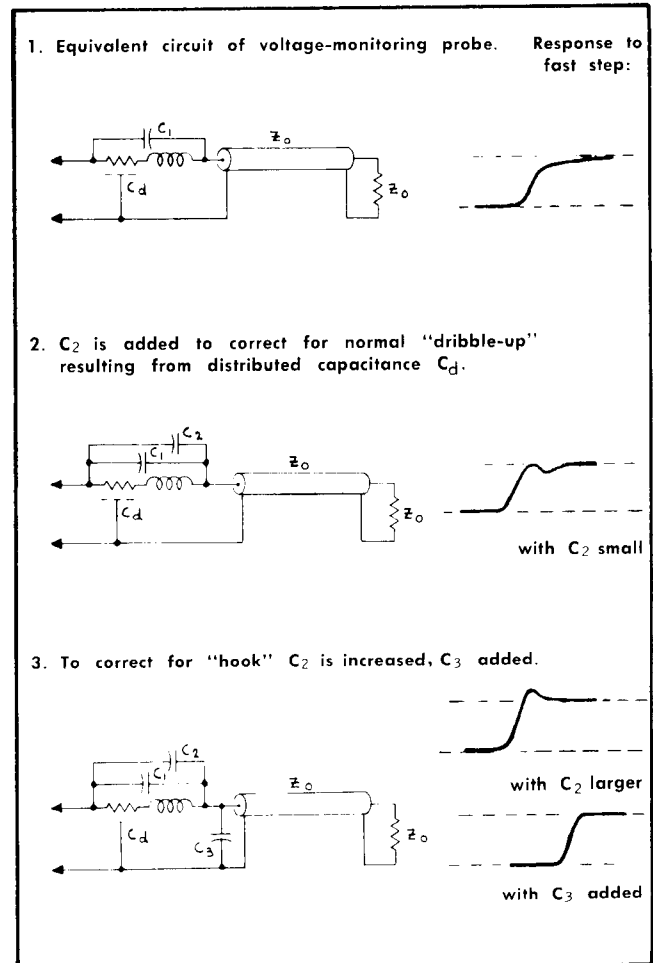

Fig. 2-20. Fractional nanosecond compensation of low resistance passive probes.

in input resistance with increasing frequency is due to the drop in reactance of the compensating capacitor across the input resistor, exposing the low-resistance parts of the probe to the input.

Since the input resistance is down at high frequencies, any series inductance will be significant. Fig. 2-21 shows an equivalent circuit of a common high-speed probe with a general curve showing that the apparent input capacitance at the 3-db down point is double the low-frequency value. Thus, when using probes to measure fractional nanosecond pulses, the signal source impedance must be low enough to drive the increased capacitance in order to assure good display fidelity.

When it is necessary to ac-couple a high-speed probe, the capacitor should be placed between the input attenuator resistor and the probe cable. This minimizes the differences between high-frequency input characteristics with and without the coupling capacitor. In this 50 Ω environment, stray capacitance to ground has a shorter and more uniform time constant than it would if the capacitor were placed next to the signal source which usually has a higher impedance of unknown value.

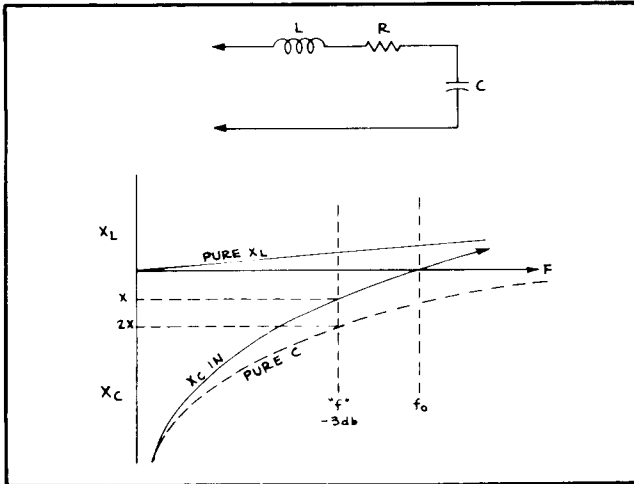

Fig. 2-21. Equivalent circuit of a high speed probe at frequency "f" and general input reactance curve to a frequency past the point of resonance.

To use a signal probe and obtain good display fidelity requires not only knowledge of the probe, but also of the circuit being measured. Fig. 2-22 is a simple example of how a signal can be distorted by the measuring system.

Fig. 2-22e shows the normal waveform at the transistor collector before connecting the probe. When the probe is connected in the manner illustrated, and the transistor is off, E_1 drops to $V_{cc}/2$ due to the voltage division between R_L and the probe resistor. Fig. 2-22f is the collector waveform with the probe connected. The initial step readily follows the input because R_t is very low compared to R_L or the probe resistance. However, when the transistor turns off, the waveform rolls off slightly because R_t becomes very high and the discharge is through the two 1-k resistors in parallel. This waveform distortion could be nearly eliminated by using a probe with a higher input resistance.

The loss in amplitude in Fig. 2-22f can be eliminated by insertion of a coupling capacitor at the input to the oscilloscope (Fig. 2-22d). In this case the initial step will still be fast, and the turn-off will be only slightly slower than before. Due to the ac-coupling, the voltage level will shift to center on the average signal level (Fig. 2-22g).

Use of the series method of coupling would be difficult in this example, unless the chassis of the device under test could be isolated from the oscilloscope chassis ground.

DIODE SWITCHING

The following is a general explanation of what happens in a diode when a forward or reverse voltage is applied.

Forward Recovery

Forward recovery occurs when a diode with no voltage applied is suddenly turned on with forward voltage. The forward voltage switches the diode current from zero to some forward equilibrium value in a certain time. The current switches because the forward voltage produces an electric field across the diode that forces carriers (electrons and holes) to move toward the PN junction.

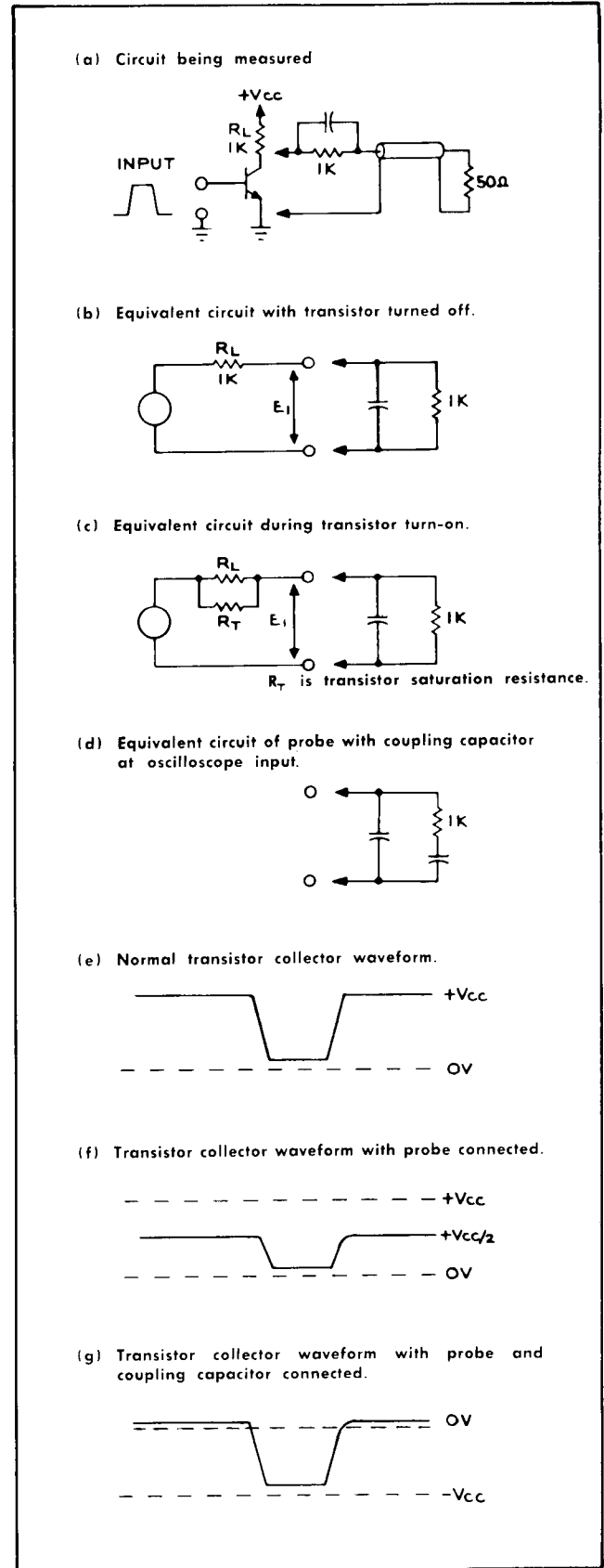

Fig. 2-22. Typical measurement problem. Waveform distortion produced by test probe must be considered.

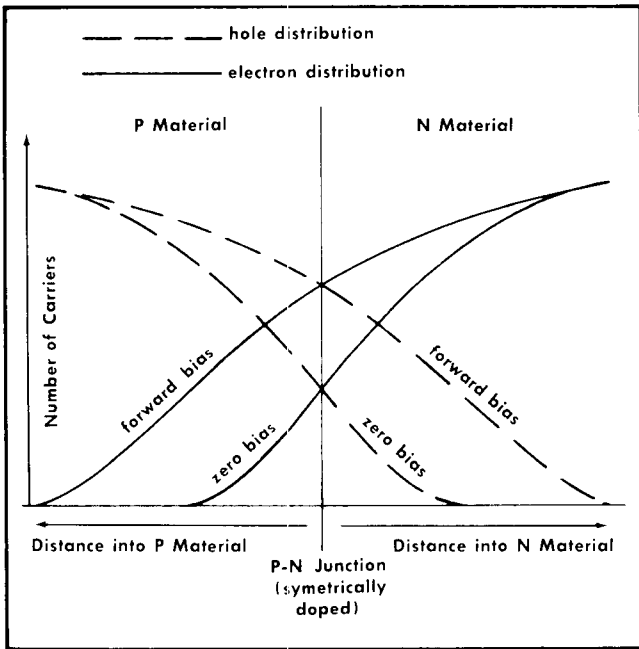

Fig. 2-23. Electron and hole distribution of PN junction.

Before switching, with zero current and no applied electric field, there are a few holes in the N material and a few electrons in the P material near the PN junction (see Fig. 2-23, zero bias).

When the forward voltage is applied, the electric field moves more carriers across the PN junction. Some of the carriers already across are moved even further (see Fig. 2-23, forward bias). The carriers crossing the PN junction are

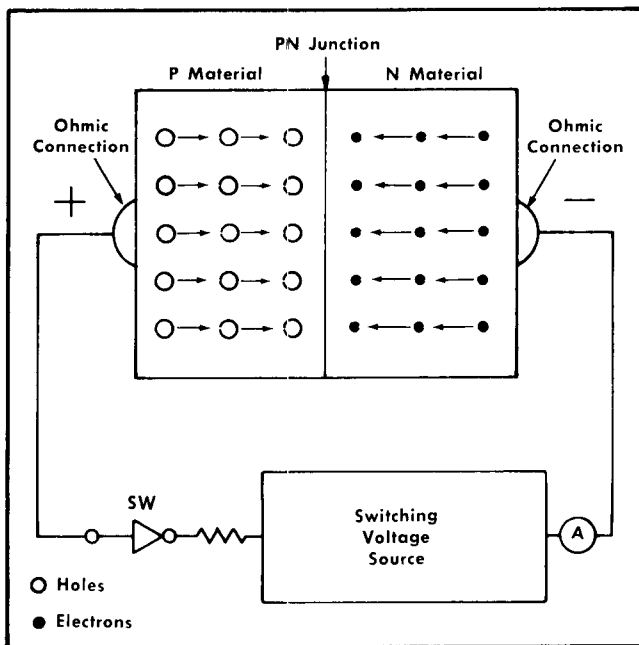

Fig. 2-24. PN diode with forward switching voltage applied.

replaced by electrons and holes sweeping toward the junction (as two masses) from the ohmic connections as shown in Fig. 2-24. When the carriers in these masses leave the ohmic connections, each is replaced by a carrier from the switching voltage source, thus starting forward diode current.

Continuous forward diode current is produced by holes combining with electrons in the region of the PN junction. When a hole combines with an electron, both are lost as carriers, but other carriers move from the ohmic connections to replace those lost, thus producing diode current. The amount of diode current depends on how far the carriers are forced across the junction by the applied electric field. (Increasing the forward voltage increases the electric field strength.)

For each value of forward voltage there is a corresponding value of forward equilibrium (steady state) diode current. At equilibrium, the rate that carriers enter the ohmic connections equals the rate that carriers are lost in the region of the PN junction.

Fig. 2-25 shows diode current changes that occur from the time forward voltage is applied until forward equilibrium current is reached.

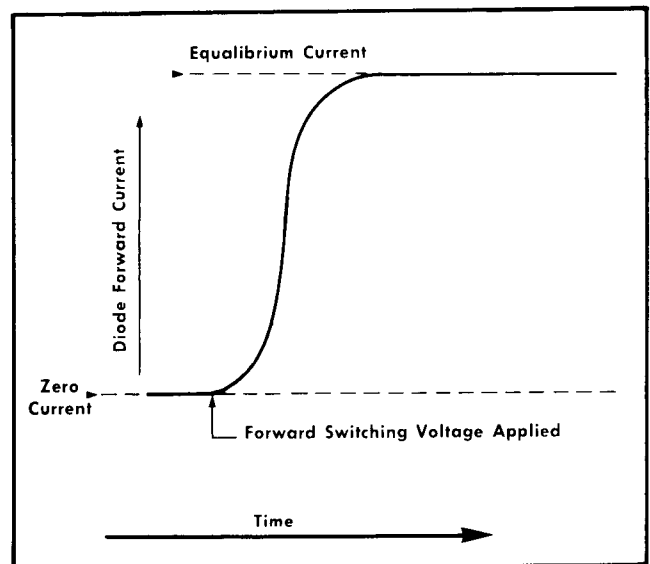

Fig. 2-25. Diode forward recovery current.

Reverse Recovery

Reverse recovery occurs when a diode with forward current suddenly has a reverse voltage applied to it. The reverse voltage generates a proportional reverse electric field that switches the diode current from a forward value, through zero, to a reverse value, then back to zero.

With forward diode current (forward voltage applied), some carriers pass through the PN junction and travel a considerable distance before they combine. Therefore, there are holes in the N material and electrons in the P material (see Fig. 2-26, forward bias). These electrons and holes form a stored charge that is distributed around the PN junction (see Fig. 2-27, t_0). The forward voltage determines the distance carriers travel past the junction, and the number

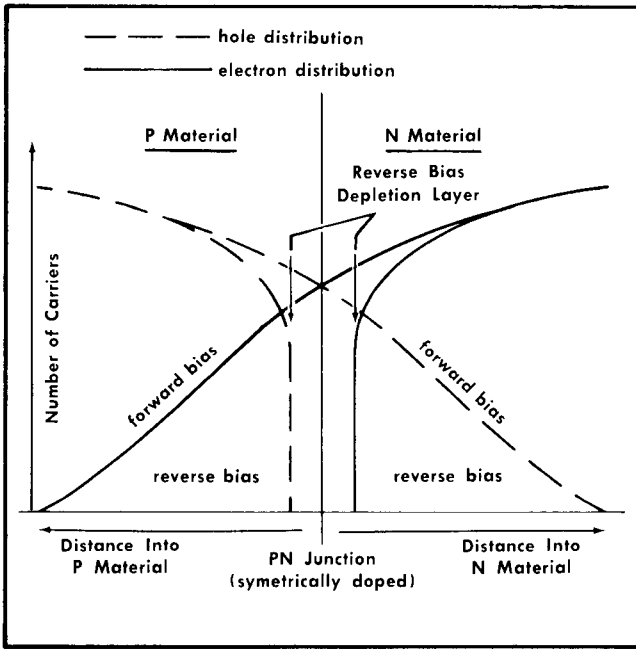

Fig. 2-26. Electron and hole distribution at PN junction.

The maximum value of this reverse diode current depends on the maximum rate that carriers move toward the ohmic connections. Carriers moving toward the ohmic connections deplete the stored charge first, then form a reverse-bias depletion layer at the PN junction as shown in Fig. 2-26.

Usually, most of the reverse diode current is supplied by the carriers in the stored charge, however some current is supplied during the formation of the depletion layer. The stored charge is depleted (in sequence indicated by t_0 , t_1 , t_2 , t_3 , and t_4 in Fig. 2-27) as holes and electrons are pulled across the PN junction toward the ohmic connections. After the stored charge is depleted, the depletion layer is formed as the holes and electrons are pulled farther from the PN junction. The size of the stored charge and the size of the depletion layer determines the number of carriers available for reverse diode current. However, the size of the stored charge has the greater effect. The reverse diode current stops when the carriers are pulled back the maximum distance from the junction by the reverse electric field. The maximum distance the carriers are pulled back from the junction (size of depletion layer) is proportional to the value of the reverse switching voltage applied.

Not all of the carriers available for reverse diode current reach the external circuit to produce current. Some of the electrons and holes combine and are lost as carriers before they reach the ohmic connections. Usually the number of these depends on the time available for them to combine after the reverse switching voltage is applied. The time available for combination can be reduced by increasing the reverse switching voltage applied, which increases the rate at which carriers are removed from the diode.

During reverse recovery, the diode reverse current changes as shown in Fig. 2-28. These changes result from the changes in the rate at which carriers leave the ohmic connections. During the time t_0 to t_2 (Fig. 2-27), when there are electrons and holes at the PN junction, the rate at which carriers leave the ohmic connections is greatest. Thus, the

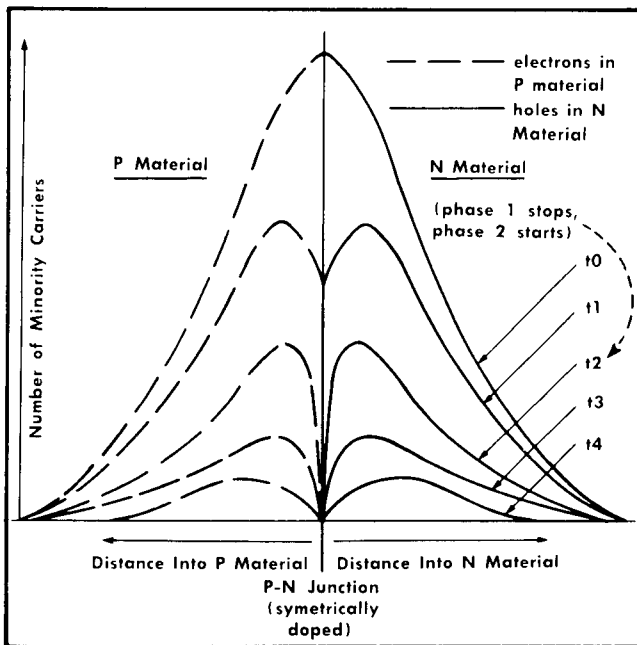

Fig. 2-27. Minority carrier (stored charge) distribution around forward biased PN junction.

that pass through the junction. Thus, the amount of stored charge is proportional to the forward voltage applied.

When reverse voltage is applied, the reverse electric field forces electrons toward the N material ohmic connection, and holes toward the P material ohmic connection. The carriers entering the external circuit from the ohmic connections produce the reverse diode current.

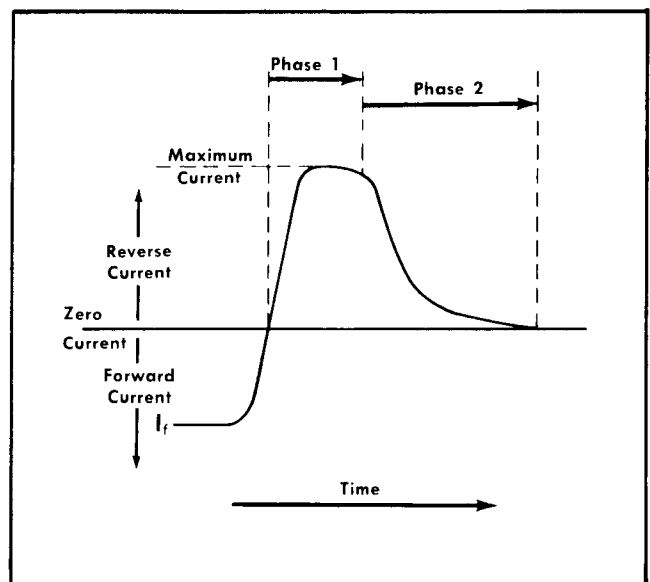

Fig. 2-28. Diode reverse recovery current.

initial diode reverse current is maximum as shown in Fig. 2-27 (phase 1). After most of the carriers are depleted at the PN junction (time t_2 in Fig. 2-27), and until the depletion layer is completely formed, the rate at which carriers leave the ohmic connections reduces to zero. Therefore, the diode reverse current reduces to zero (disregarding leakage current) as shown in Fig. 2-28 (phase 2).

During reverse recovery, changes in reverse diode current depend on both the diode and the voltages applied. The value of forward voltage applied before the diode is switched determines the size of the stored charge (number of available carriers). The size of the reverse voltage determines the maximum diode current, the number of available carriers recovered as reversed diode current, and the size of the reverse bias depletion layer.

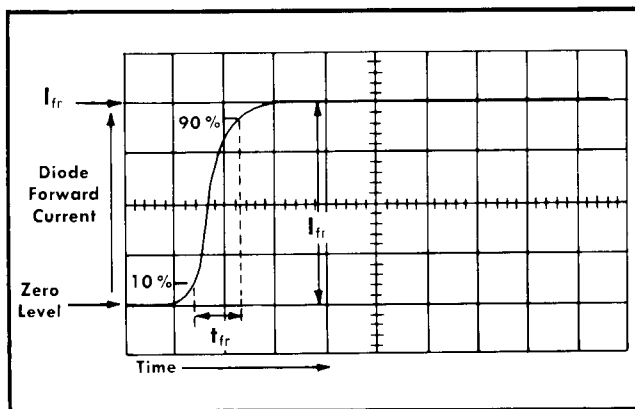

Fig. 2-29. Diode forward recovery switching display.

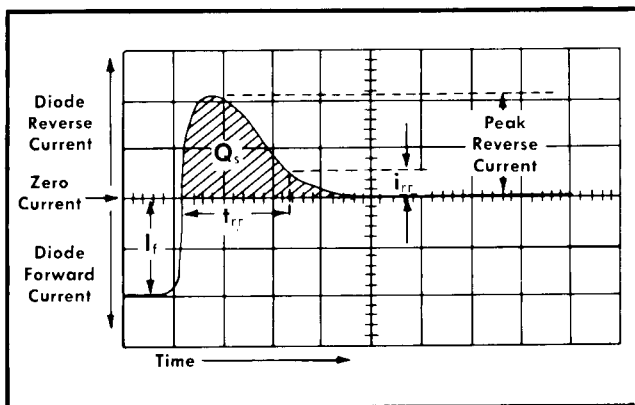

Fig. 2-30. Diode reverse recovery switching display.

Diode Switching Terms (See Figs. 2-29 and 2-30)

Forward Turn-On Current (I_{fr})—Maximum (equilibrium) value to which the forward current rises after the diode is switched with a forward switching voltage.

Forward Turn-On Time (t_{fr})—Time it takes the diode forward current to rise from 10% to 90% of the Forward Turn-On Current (I_{fr}) after the diode is switched with a forward switching voltage.

Forward Current (I_f)—Amount of forward current (steady state) passing through the diode before a reverse switching voltage is applied.

Reverse-Recovery Current (i_{rr})—Specified amount of reverse current to which a diode recovers when measuring Reverse-Recovery Time (t_{rr}).

Reverse-Recovery Time (t_{rr})—Time interval measured from the time a reverse switching voltage is applied and the diode current reverses (zero current level) to the time the falling diode current reaches the Reverse-Recovery Current (i_{rr}) level.

Stored Charge (Q_s)—Amount of charge stored by the diode, and recovered during reverse recovery. Represented by shaded area in Fig. 2-30, and usually stated in coulombs.

Tau-Sub-Que (τ_q)—Amount of charge stored by the diode, and recovered during reverse recovery for each unit of forward current ($\frac{Q_s}{I_f}$). τ_q (usually expressed in picocoulombs per milliampere) is a convenient figure of merit for comparing possible recovery time in switching diodes.

Tau-Sub-EI (τ_L)—The lifetime constant of the stored charge in the diode junction.

Final Recovery Voltage (V_r)—Final recovery voltage across diode when measuring reverse-recovery characteristics. When given as volts in a 100-ohm loop ($R_L = 100$ ohms), use the following formula to find generator voltage into a 40-50-ohm load (E_{gen}).

Generator Voltage Into 50-Ohm Load (E_{gen})—Generator voltage used to test diode. When V_r is given for reverse-recovery, such as volts in a 100-ohm loop ($R_L = 100$ ohms), approximate E_{gen} can be determined by:

$$E_{gen} \cong \frac{V_r + (Z_L I_f)}{2} \text{ where } Z_L = \frac{R_L}{2}$$

For 50-ohm input, 50-ohm output leads: $R_L = 100$ ohms. For example: if $V_r = 6$ volts, $I_f = 10$ ma and $R_L = 100$

$$\text{ohms, then } E_{gen} \cong \frac{6 + (50 \times 0.1)}{2} = 3.25 \text{ volts.}$$

Forward-Switching Voltage—A negative voltage applied to the diode cathode, or a positive voltage applied to the anode.

Reverse-Switching Voltage—A negative voltage applied to the diode anode, or a positive voltage applied to the cathode.

DIODE MEASURING TECHNIQUES

The following is a discussion of techniques for measuring forward- and reverse-recovery switching characteristics of a diode. Forward recovery when occurs when a diode switches from zero current to some forward current value when a forward-switching pulse is applied. Reverse recovery occurs when the current through a diode is switched from some

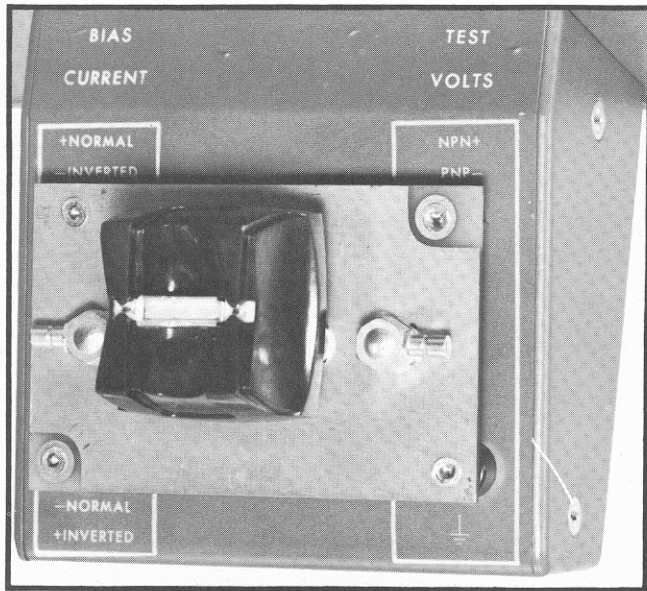

Fig. 2-31. Diode test fixture.

forward value, through zero to a reverse value, then back to zero, by applying a reverse switching pulse.

In addition to the Type 292 and test fixture, a fast-rise pulse generator and an oscilloscope are required (see "Pulse Generator and Oscilloscope Requirements"). The basic test system is shown in Figs 2-31 and 2-32. The oscilloscope is

dc coupled, and 50-ohm coaxial cables are used throughout the system. To eliminate possible reflected pulses in the recovery display, the time delay in the cable between the pulse generator and Type 292 should be longer than the recovery time of the diode under test. If the pulse generator has a trigger output, it can be used to externally trigger the oscilloscope.

Vertical display voltage is obtained by diode current passing through the oscilloscope 50-ohm input impedance, thus providing 1 millivolt for each 20 microamps of diode current. The display voltage generated by the diode current can be reduced by connecting an attenuator between the test fixture and the oscilloscope, as shown in Fig. 2-32. However, with an attenuator between the test fixture and the oscilloscope, the current sensitivity is reduced by the attenuation factor. For example, if a 10X attenuator is used, each millivolt displayed equals 200 microamps of diode current.

Pulse Generator and Oscilloscope Requirements

The pulse generator should have a 50-ohm output impedance, and provide a fast-rise pulse for diode switching. Pulse risetime should be less than the diode recovery time. The pulse duration should be longer than the diode reverse recovery time.

The pulse amplitude should be sufficient to satisfy either the switching voltage (E_{gen}) or maximum reverse current requirements. The pulse should not exceed half the diode breakdown voltage to avoid damage from the 50-ohm transmission line voltage-doubling effect caused when the genera-

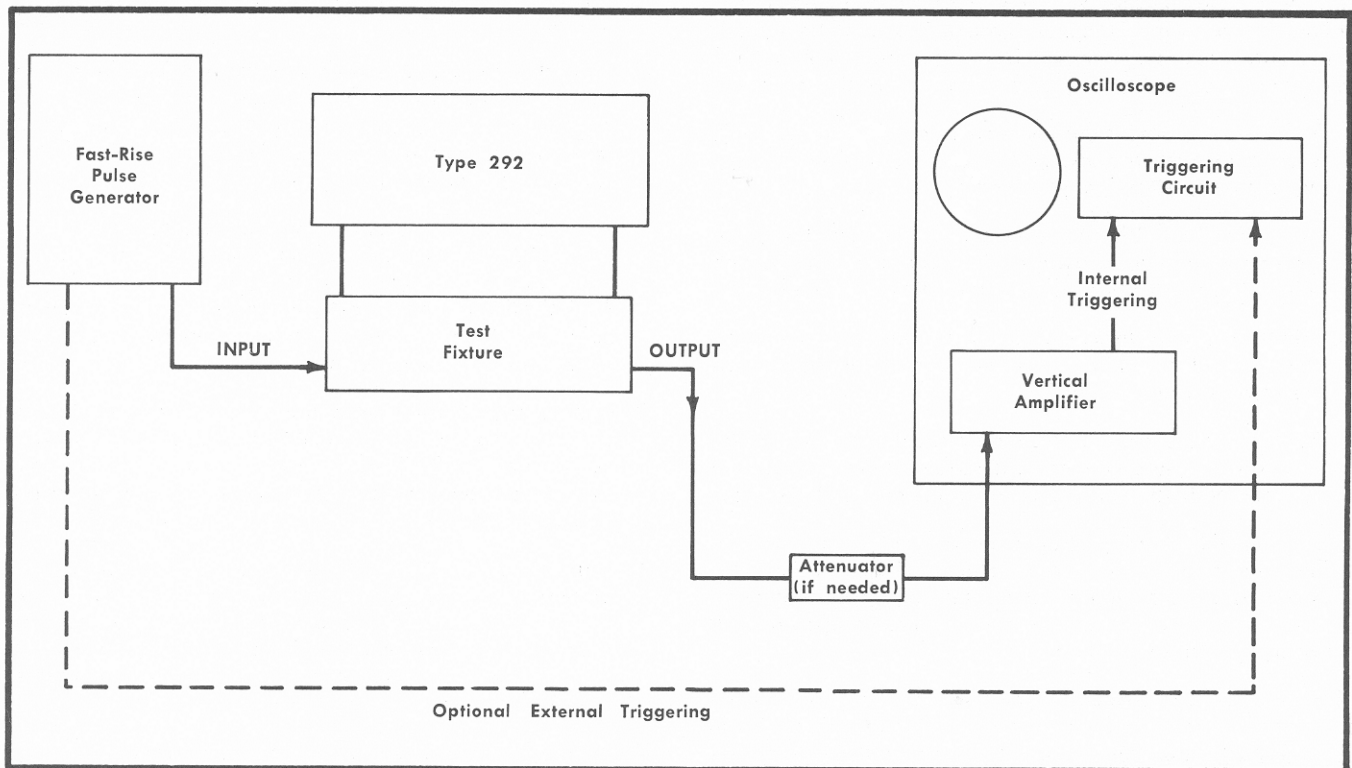

Fig. 2-32. Basic test system.

Operating Instructions—Type 292

tor is unloaded as the diode recovers. Pulse repetition rate should be slow enough for the diode to recover between pulses. A Tektronix Type 109 or Type 110 will meet these needs.

The oscilloscope used should have a 50-ohm input impedance, and be able to display risetime fast enough to measure the switching characteristics of the diode under test. Tektronix sampling oscilloscopes, such as the Type 567/3S76/3T77/6R1 and Type 661/4S1/5T1A, will meet these needs.

Diode Current Sources

The Type 292 Bias Current supply can furnish up to 200 milliamps. This current is normally applied to the test circuit by inserting a test fixture into the test platform. See Section 1, "Optional Accessories".

An external constant-current supply may also be used to provide current to the test circuit through the BIAS CURRENT MONITOR/EXT PWR jack. However, the current should not exceed 1 ampere.

To monitor the test-circuit current, connect a milliammeter between the current SOURCE and LOAD jacks. The meter will indicate diode current between switching pulses. (The meter is electrically isolated from the switching pulses by circuitry on the diode test fixture.)

Forward-Recovery Switching Characteristics

An oscilloscope display for measuring forward-recovery switching characteristics of a diode can be obtained by the following procedure. Steps 1 through 6 should be used if the forward-switching voltage is known. Steps 4 through 7 should be used if the forward turn-on current (I_{fr}) is known.

1. With the test equipment connected as shown in Fig. 2-32, short across the test fixture by inserting a piece of $1/16$ " wide copper strap as you would a diode.
2. With the Type 292 power supplies off, turn the pulse generator and oscilloscope on. Set the oscilloscope vertical controls for a voltage-calibrated deflection.
3. Obtain a stable display of the pulse generator output on the crt, and adjust the generator output for the desired forward-switching voltage.
4. With the pulse generator turned off, calibrate the oscilloscope to measure current as described under "Measuring Current With The Oscilloscope", at the end of this section.
5. Remove the shorting strap from the test fixture and insert the diode to be tested. (Place cathode of diode toward oscilloscope input if the output of the pulse generator is positive, or anode toward oscilloscope input if generator pulse is negative.)
6. Turn the pulse generator on, and set the oscilloscope triggering controls for a display similar to that shown in Fig. 2-29. Use this display to measure the forward-recovery switching characteristics of diodes when the forward switching voltage is known. Proceed to step 7 if I_{fr} is known.

7. Set the pulse generator output for the known I_{fr} indication on the display (see Fig. 2-29). Use this display to measure the forward-recovery switching characteristics of diodes when I_{fr} is known.

NOTE

Any number of diodes with the same specifications can be measured by repeating step 6 or 7, whichever applies.

Reverse-Recovery Switching Characteristics

An oscilloscope display for measuring the reverse-recovery switching characteristics of a diode can be obtained by the following procedure. Perform steps 1 through 8 if V_r is known (from which E_{gen} is calculated). Use steps 4 through 9 if the peak reverse current is known.

1. With the test equipment connected as shown in Fig. 2-32, short across the test fixture by inserting a piece of $1/16$ " copper strap as you would a diode.
2. With the Type 292 power supplies off, turn the pulse generator and oscilloscope on. Set the oscilloscope vertical controls for a voltage-calibrated deflection.
3. Obtain a stable display of the pulse-generator output on the crt, and adjust the generator output for the desired E_{gen} .
4. With the pulse generator turned off, calibrate the oscilloscope to measure current as described under "Measuring Current With The Oscilloscope" at the end of this section.
5. With the Type 292 power supplies off, obtain a free-running sweep on the oscilloscope and vertically position the trace to a convenient graticule line. (This establishes a zero current reference; therefore, do not change the vertical position during the rest of this procedure.)
6. With a free-running sweep on the oscilloscope, set the Type 292 (or external current source, if used) center BIAS CURRENT switch to INVERTED; then adjust the left BIAS CURRENT and VARIABLE controls to give a vertical deflection from the zero current reference that represents the value specified as I_r .
7. Remove the shorting strap from the test fixture, and insert the diode under test (place anode of diode toward oscilloscope input if output of pulse generator is positive, or cathode toward oscilloscope input if generator pulse is negative).
8. Turn the pulse generator on, and set the oscilloscope triggering controls for a display similar to that shown in Fig. 2-30. Use this display to measure the reverse-recovery switching characteristics of diodes whose V_r (then E_{gen}) is known. Proceed to step 9 if the peak reverse current is known.
9. Set the pulse generator output for the known peak reverse current indication on the display. Use this display to measure the reverse-recovery switching characteristics of diodes whose peak reverse current is known.

NOTE

Any number of diodes with the same specifications can be measured by repeating step 8 or 9, whichever applies.

Measuring Current With The Oscilloscope

The oscilloscope vertical deflection can be calibrated to measure current as follows:

1. Connect the test equipment as shown in Fig. 2-32 (the pulse generator is not needed for this procedure, but is necessary when measuring diode switching characteristics), and set the Type 292 bias current VARIABLE control to CALIB and the left BIAS CURRENT mAmps control to 10.
2. Short across the test fixture by inserting the copper strap as you would a diode.
3. Set the Type 292 center BIAS CURRENT switch to INVERTED and obtain a free-running sweep on the oscilloscope.
4. Set the oscilloscope vertical controls for any convenient deflection to equal 10 milliamps of diode current as the Type 292 center BIAS CURRENT switch is alternated between OFF and INVERTED. For example, to calibrate the crt for 5 milliamps/division, set the vertical controls for 2 divisions of vertical deflection while alternating between the BIAS CURRENT switch OFF and INVERTED positions. Diode current can now be accurately measured as a direct function of crt vertical deflection.

SECTION 3

CIRCUIT DESCRIPTION

The Type 292 Semiconductor Tester Power Supply circuitry contains two transistorized regulated supplies. The supplies act independently but are supplied from a common power transformer. Each supply contains its own reference system against which the output is compared.

The Test Volts supply is a series-compensating type, in which current feedback changes the collector resistance of a transistor (Q637) in series with the load. The reference voltage is double Zener diode regulated for stability with varying line voltage. All components have power ratings large enough to allow a short duration external short circuit without damage. It is advisable to remove any short within a few minutes.

Line voltage is applied through fuse F601 and the TEST VOLTS and BIAS CURRENT switches to the primary windings of the power transformer T601. Both supplies are energized when one supply is turned on, but there is no output from the other supply. Both supplies have two-diode full wave rectifiers. The diagram shows normal voltages at various points in the circuits.

The Bias Current supply is a series-compensating type, in which the current limit is partially set by a degenerative emitter resistor (R687) in the feedback circuit. The reference voltage Zener diode is supplied by a constant current (transistor) source to essentially eliminate reference errors due to line voltage changes.

Test Volts Supply

The two-diode full-wave rectifier circuit from terminals 6, 7, and 8 of T601 supplies power to the Test Volts regulator circuit. The unregulated voltage is double RC filtered. The filter resistors also help to limit short-circuit current. The no-load voltage across C605 is about 44 volts dc.

The regulator circuit action is essentially that of comparing the stable voltage across R624 to the output voltage at the emitter of comparator transistor Q634.

The reference voltage across D619 and D620, combined with the relatively large resistance in the emitter of Q624, sets a stable and constant current in the resistor string R624. The high-impedance collector of Q624 allows the voltage level of R624 to vary with essentially no change in current. The reference voltage is compared with the output voltage at the emitter-base junction of Q634.

An error in output voltage is a change in voltage across R631 (and the load in parallel). A change in voltage across the load causes a change in collector current of Q634. The change in collector current of Q634 then changes the base current of Q637 in the same phase as the original error. Q637 collector inverts the correcting signal to restore the output voltage to the same level as before the error occurred. Q637 restores the output voltage by acting as a dynamic variable resistor in series with the load that changes its resistance to correct for changes of voltage across the load.

When the TEST VOLTS switch is set for one volt output, most of the rectifier output (44 volts no load) appears across Q637. When the TEST VOLTS switch is set for 20 volts output, about 24 volts appears across Q637.

The regulator circuit is designed to correct the output voltage for moderately fast changes in load. High-frequency changes in the load are compensated by the energy stored in output capacitor C640. Very-high-frequency changes, such as in pulse work, require special decoupling circuits on the test fixture because of lead inductance between the supply and the fixture.

In the event of a short circuit on the output, output transistor Q637 is protected against excessive base current from the collector of Q634 by catching diodes D636-D637. The catching diodes are silicon, and will pass current when the base of Q637 exceeds about 1.2 volts positive with respect to the rectifier negative bus.

The supply has first order temperature compensation by silicon diode D619 in series with Zener diode D620, and by silicon diode D624 in series with the reference resistor string R624. These two diodes compensate for temperature changes in both Q624 and Q634.

Bias Current Supply

The two-diode full wave rectifier circuit from terminals 9, 10, and 11 of T601 supplies power to the Bias Current regulator circuit. The unregulated voltage is double RC filtered. The no-load voltage across C655 is about 45 volts, and about 40 volts at 100 ma load.

The regulator circuit action is essentially that of comparing the stable voltage across Zener diode D674 and the voltage developed across one of the R687 resistors at the emitter-base junction of Q684.

The reference voltage is made stable by Zener diode regulating the base voltage of Q674 while at the same time making Q674 emitter circuit degenerative. The high impedance of the collector of Q674 permits the supply side of Zener diode D674 to change without a change in current in the diode. The reference voltage circuit is then double Zener diode regulated with the second diode in a constant current condition.

The base of comparator Q684 receives some fraction of the reference voltage, the value set by R676 and R677 in series. Any change in supply output current causes a change in voltage across the active R687 resistor. The bias on Q684 is then changed, changing the drive to the base of series transistor Q687.

Regulator action is as follows: a change in current changes the drive to Q687 in the direction so Q687 changes its collector resistance to restore the output current to its ori-

Circuit Description—Type 292

ginal value. The output current is set by the combination resistance of an R687 resistor in series with Q687 and the load.

The regulator circuit is designed to correct the output current for moderately fast changes in load. High-frequency load changes are partially compensated for by C679. Very-high-frequency changes, such as in pulse work, require special decoupling circuits on the test fixture because of lead inductance between the supply and the fixture.

In the event of an open circuit, the output voltage rises to about 40 volts. The regulator will operate correctly when the load resistance is such that the load current causes the load voltage to be 20 volts or less.

The Bias Current supply does not have a dc ground connection inside the Type 292. Capacitors C662-C663 balance the power transformer secondary capacitance currents to

minimize output current ripple and make it possible to switch output polarity without seriously degrading the ripple.

Common Circuit Ground

The only connection between the two supplies and the chassis is on the test fixture platform at the Test Volts lower right-hand jack (facing the instrument). The single ground permits the Bias Current supply to be associated with the Test Volts supply, at either polarity, through an impedance of the transistor being tested.

The ground connection may be moved to any point as required by a particular test. Or, the Bias Current supply may have one of its leads grounded through the hookup of the test fixture. Any grounding system that suits the test can be connected by the user.

SECTION 4

MAINTENANCE

If trouble occurs in the Type 292, make sure the associated equipment is operating properly and the controls are set correctly. Improper control settings may cause trouble symptoms. Also, if the TEST VOLTS or BIAS CURRENT controls are set too high, transistors may be damaged. If the fast-rise input pulse is of the wrong polarity, the transistor will not be tested properly.

If you are certain of trouble in the Type 292, a visual check may reveal the cause. Defects such as loose or broken connections, frayed or broken cables, damaged connectors, burned components, and broken switches can generally be detected by a visual inspection. Except for heat-damaged components, the remedy for these defects is obvious. Since heat damage is usually the result of other, less apparent, trouble, be sure to locate the source before replacing components.

If the cause cannot be seen, it can usually be located by performing the following circuit checks. Follow instructions under Removing and Replacing Parts near the end of this section before removing or replacing defective components. Troubleshooting and periodic maintenance are based on the following circuit checks.

Test Fixture Circuit Check

Each part of the test fixture circuit is checked by inserting a fast-rise pulse into the circuit (tester deenergized) and observing the resulting output signal. The fast-rise pulse is used to compare the transit time and compensation. See the Operating Instructions section of this manual.

Power Supply Check

Check the power supplies by measuring the output voltages, currents, and ripple as described in the calibration procedure Section 5.

Removing and Replacing Parts

Most parts in the Type 292 can be replaced without detailed instructions. Some, however, are best removed and replaced by using definite procedures contained in the following paragraphs. Parts ordering information is included in the Parts List section of this manual.

Whenever a part has been replaced, check and adjust the instrument calibration as necessary.

Access To The Interior

To gain access to the interior of the Type 292, remove the screws on the back of the tester and remove the back panel. Then lift off the warp-around housing.

CAUTION

When operating the Type 292 without the wrap-around housing, be sure to connect the power cord properly. If care is not used, the cord can be connected 120-degrees from the correct position.

Soldering Precautions and Procedures

The etch-wired circuit board in the Type 292 has been constructed of the finest materials using the best construction techniques known. Each component hole is "through plated" to the opposite side of the board, giving it unusual strength and resoldering durability. Components can be removed and replaced on the circuit board numerous times with no fear of lifting the etched circuit from the glass laminate.

Use a 50-to 75-watt soldering iron with a small wedge-shaped tip. Use needle nose pliers to grip the component lead next to its body before applying heat. Apply heat and lift the lead out of its mounting hole.

When installing a new component, bend the leads to match the length and position of the leads of the removed part. It may help to heat the mounting hole with a liquid state and shake out the excess.

Tin the prepared leads of the new part, then heat the mounting hole and install the new part.

Do not apply excessive heat. Use sufficient heat, however, along with a small amount of new solder, to establish a full flow clean joint.

When replacing switches, be sure to use solder sparingly so that new solder does not flow into the contact area. Use enough solder to form a small fillet around the wire as it passes into and through the contact solder-point.

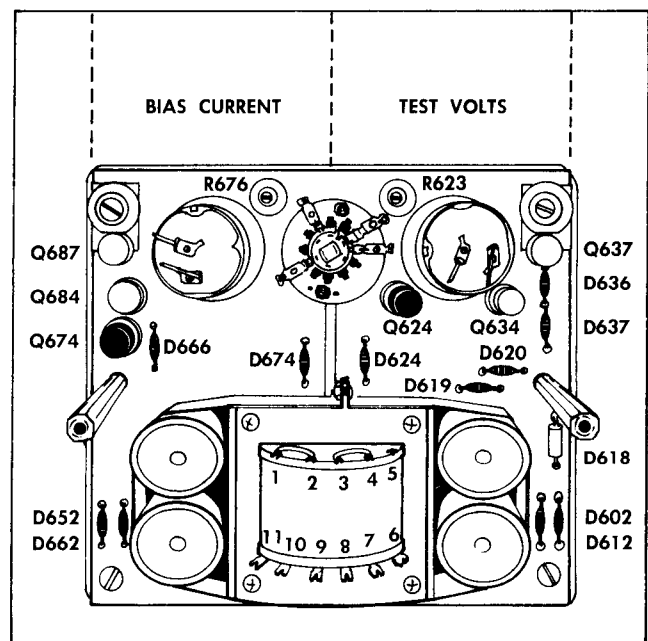

Fig. 4-1. Semiconductor locations inside Type 292.

Maintenance—Type 292

Replacing Switches

Normally, if one wafer is defective in a switch, the entire switch should be replaced. Switches can be ordered from Tektronix, without the VARIABLE controls mounted.

Checking Semiconductors

Trouble in the Type 292 could be due to semiconductor failure. Semiconductors can be checked by replacing a suspected one with one of the same type or by using a tester.

Semiconductors can also be checked with an ohmmeter if no other method is available. However, resistance readings of semiconductors of the same type may vary. Therefore, resistance readings are valid only when checking for front-to-back resistance, opens, and shorts. Avoid using the RX1

scale of the ohmmeter because the high current of this scale can damage a good semiconductor.

Replacing Transistors

A defective series transistor (Q637 or Q687) can be removed after its heat sink has been loosened. Free the heat sink by simply removing the mounting bolt. Unsolder the leads carefully if you are going to test the transistor out of its circuit. Replace the new transistor by first securing the heat sink, and then carefully soldering the leads in place. Replace the insulating mica washer in its identical position between the mounting bolts washer and the heat sink plate.

The other transistors are socket mounted, and their removal and replacement does not require soldering.

SECTION 5

CALIBRATION

The Type 292 has only two internal adjustments . . . R623 in the Test Volts supply, and R676 in the Bias Current supply. Since the power supplies contain precision parts, adjustments should be checked after each 500 hours of operation, or at least every six months. If trouble develops in the Type 292, the information in this section may help you determine the cause.

Equipment Required

1. A variable line-voltage autotransformer, rated at 50 watts or more.
2. A precision dc voltmeter, capable of measuring from 100 millivolts through 20 volts at an accuracy of 0.2%.
3. A sensitive oscilloscope capable of measuring 120-cycle power supply ripple, 1 mv peak-to-peak, such as a Tektronix Type 502, 503, 530-Series with D Unit, 540-Series with D Unit, or 560-Series with 2A63 Unit.
4. Two precision resistors: A 100-ohm, 8 to 10 watt, and a 1000-ohm, 1/2 watt, $\pm 0.5\%$ each, fitted with banana plugs as shown in Fig. 5-1.
5. A coax cable about 42 inches long to permit the test oscilloscope to be connected to the resistors of item 4.

PROCEDURE

TEST VOLTS Supply

1. Connect the Type 292 to the autotransformer, and set the autotransformer output to 117 volts.
2. Set the Type 292 controls:

TEST VOLTS (right switch)	1
Test Volts VARIABLE	CALIB
TEST VOLTS (center switch)	NPN
BIAS CURRENT (center switch)	OFF
Bias Current controls	Any position

Let the Type 292 warm up 5 minutes before proceeding. Check that both shorting straps are in place in the rear monitor jacks.

3. Remove the back cover plate from the Type 292. Connect the 100-ohm resistor to the two banana jacks of test fixture marked TEST VOLTS. Connect the precision voltmeter across the 100-ohm resistor, set to read 1 volt. The voltage should be +1 volt ± 30 mv.
4. Check the output voltage for the other positions of the right hand TEST VOLTS switch, as listed in Table 5-1.

If any voltage is out of tolerance, readjustment of R623 may bring all voltages within tolerance. If one voltage (or more) is out of tolerance and adjusting R623 cannot bring all voltages within tolerance, one (or more) R624 resistors is out of tolerance and must be replaced.

TABLE 5-1
TEST VOLTS Supply Checks
(100-ohm load) NPN+ output

TEST VOLTS Switch Position	Voltage
1	+1 v ± 30 mv
2	+2 v ± 60 mv
5	+5 v ± 150 mv
10	+10 v ± 300 mv
20	+20 v ± 600 mv

5. Repeat the checks of Table 5-1 with the output voltage PNP—.
6. Slowly turn the Test Volt VARIABLE control counterclockwise. The output voltage should drop to less than 1/10 the calibrated voltage.

Reset the VARIABLE control fully clockwise.

7. Remove the voltmeter. Set the output voltage to 1 volt, NPN+. Remove the 100 Ω resistor. Connect the test oscilloscope to the TEST VOLTS terminals and set the controls as follows:

Volts/Div	1 mv/div
Time/Div	5 msec/div
Triggering	Line

The oscilloscope will show the 120-cycle ripple on the Test Volts supply voltage. Ripple testing is done without a load at 1-volt output, and with a 100-ohm load at all other output voltages. The ripple should be not greater than 4 mv peak-to-peak at any output from line voltages of 105 to 125 volts.

BIAS CURRENT Supply

1. Set the Type 292 controls:

BIAS CURRENT (center switch)	NORMAL
BIAS CURRENT (left switch)	5 mAMPS
Bias Current VARIABLE	CALIB
TEST VOLTS (center switch)	OFF
Test Volts controls	Any position

Connect the 1000-ohm resistor to the BIAS CURRENT jacks on test fixture platform as in Fig. 5-2.

2. Connect the precision voltmeter to the 1000-ohm resistor, set to read 5 volts. The voltage should be +5 volts ± 150 mv.
3. Check the voltage across the resistor for the other positions of the left BIAS CURRENT switch, as listed in Table 5-2. Note that the 100-ohm resistor is used in the 5 highest current positions. Adjust R676 if the voltage is out of tolerance.

TABLE 5-2
BIAS CURRENT Supply Checks

BIAS CURRENT Switch Position	Load Res.	Voltage
5	1 k	5 v \pm 150 mv
.1	1 k	100 mv \pm 3 mv
.2	1 k	200 mv \pm 6 mv
.5	1 k	500 mv \pm 15 mv
1	1 k	1 v \pm 30 mv
2	1 k	2 v \pm 60 mv
5	1 k	5 v \pm 150 mv
10	100 Ω	1 v \pm 30 mv
20	100 Ω	2 v \pm 60 mv
50	100 Ω	5 v \pm 150 mv
100	100 Ω	10 v \pm 300 mv
200	100 Ω	20 v \pm 600 mv

If any reading is out of tolerance, readjustment of R676 may bring all readings within tolerance. If one reading (or more) is so far out of tolerance that R676 cannot bring it within tolerance, one or more R687 resistors must be replaced.

4. Repeat the checks of Table 5-2 with the output at PNP—.

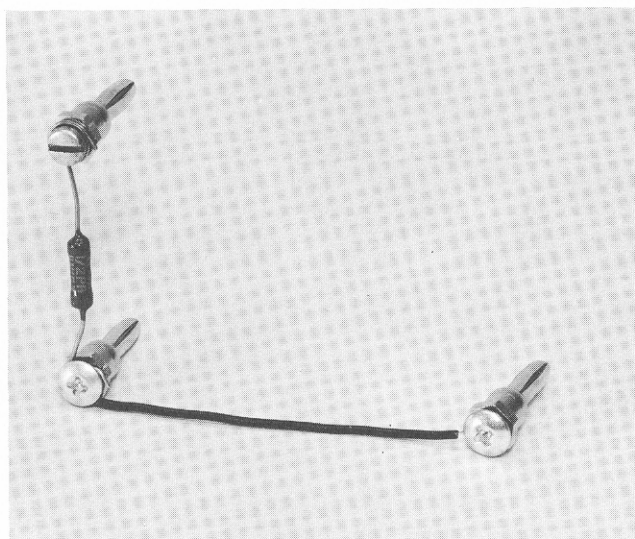

Fig. 5-1. Test resistor assembly.

- Slowly turn the Bias Current VARIABLE control counter-clockwise. The voltage reading should drop to less than 1/10 the calibrated value.
- Remove the voltmeter. Reset the VARIABLE control fully clockwise, output to NPN+. Install the 1000-ohm resistor in the BIAS CURRENT jacks.

Connect the test oscilloscope across the resistor and set the controls as in the TEST VOLTS procedure. The oscilloscope will now show 120-cycle ripple on the Bias Current supply. The ripple signal should not exceed 4 mv peak-to-peak.

Check the ripple of other current values of the Bias Current supply as listed in Table 5-3.

TABLE 5-3
BIAS CURRENT Ripple Checks

BIAS CURRENT Switch Position	Load Res.	Ripple Peak-To-Peak
.1 thru 20	1 k	4 mv = 4 μ a
50	100 Ω	0.8 mv = 8 μ a
100	100 Ω	1.5 mv = 15 μ a
200	100 Ω	7.5 mv = 75 μ a

The ripple should be no greater than in Table 5-3 at line voltages from 105 to 125 volts.

7. Repeat the checks of Table 5-3 with the output at PNP—.

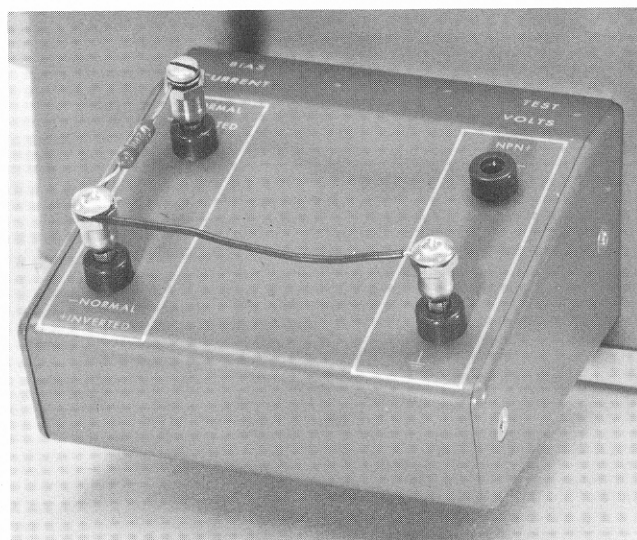

Fig. 5-2. Correct resistor mounting for Bias Current supply checking.

SECTION 6

PARTS LIST AND DIAGRAMS

PARTS ORDERING INFORMATION

Replacement parts are available from or through your local Tektronix Field Office.



Changes to Tektronix instruments are sometimes made to accommodate improved components as they become available, and to give you the benefit of the latest circuit improvements developed in our engineering department. It is therefore important, when ordering parts, to include the following information in your order: Part number including any suffix, instrument type, serial number, and modification number if applicable.

If a part you have ordered has been replaced with a new or improved part, your local Tektronix Field Office will contact you concerning any change in part number.

ABBREVIATIONS AND SYMBOLS

a or amp	amperes	mm	millimeter
BHS	binding head steel	meg or M	megohms or mega (10^6)
C	carbon	met.	metal
cer	ceramic	μ	micro, or 10^{-6}
cm	centimeter	n	nano, or 10^{-9}
comp	composition	Ω	ohm
cps	cycles per second	OD	outside diameter
crt	cathode-ray tube	OHS	oval head steel
CSK	counter sunk	p	pico, or 10^{-12}
dia	diameter	PHS	pan head steel
div	division	piv	peak inverse voltage
EMC	electrolytic, metal cased	plstc	plastic
EMT	electrolytic, metal tubular	PMC	paper, metal cased
ext	external	poly	polystyrene
f	farad	Prec	precision
F & I	focus and intensity	PT	paper tubular
FHS	flat head steel	PTM	paper or plastic, tubular, molded
Fil HS	fillister head steel	RHS	round head steel
g or G	giga, or 10^9	rms	root mean square
Ge	germanium	sec	second
GMV	guaranteed minimum value	Si	silicon
h	henry	S/N	serial number
hex	hexagonal	t or T	tera, or 10^{12}
HHS	hex head steel	TD	toroid
HSS	hex socket steel	THS	truss head steel
HV	high voltage	tub.	tubular
ID	inside diameter	v or V	volt
incd	incandescent	Var	variable
int	internal	w	watt
k or K	kilohms or kilo (10^3)	w/	with
kc	kilocycle	w/o	without
m	milli, or 10^{-3}	WW	wire-wound
mc	megacycle		

SPECIAL NOTES AND SYMBOLS

X000	Part first added at this serial number.
000X	Part removed after this serial number.
*000-000	Asterisk preceding Tektronix Part Number indicates manufactured by or for Tektronix, or reworked or checked components.
Use 000-000	Part number indicated is direct replacement.
	Internal screwdriver adjustment.
	Front-panel adjustment or connector.

EXPLODED VIEW

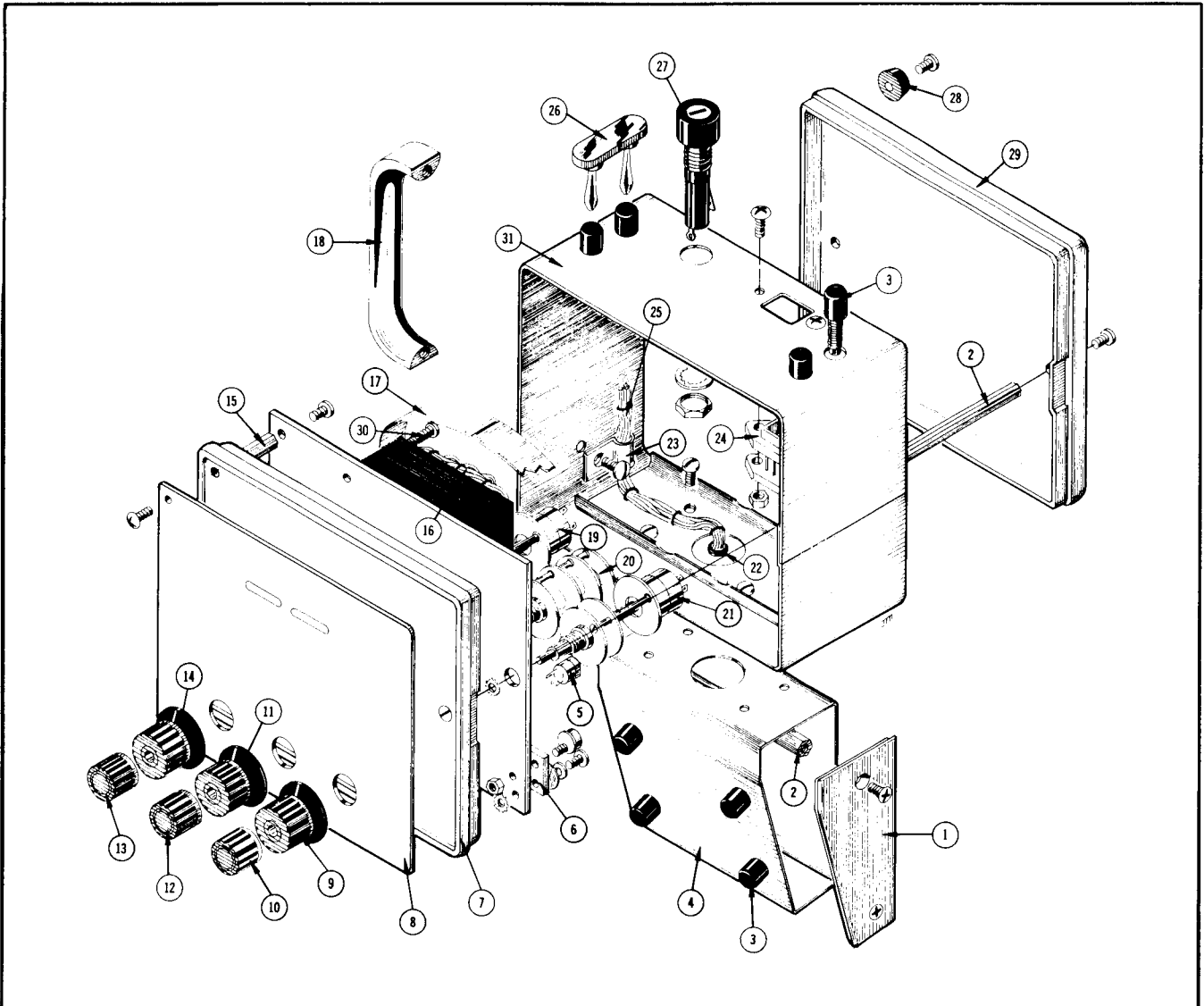

REF. NO.	PART NO.	SERIAL NO.		QTY.	DESCRIPTION
		EFF.	DISC.		
.	016-054			1	SEMI-CONDUCTOR TESTER POWER SUPPLY
1	200-561			1	Includes: COVER, housing, right
	200-560			1	COVER, housing, left, (not shown)
	211-541			2	Mounting Hardware: (not included) SCREW, 6-32 x 1/4 inch FHS 100° CSK phillips
2	385-167			4	ROD, spacer 1/4 inch hex rod 3.535 inch long
3	136-140			8	SOCKET, banana jack assembly with charcoal cap
	210-819			1	Mounting Hardware: (not included) WASHER, bakelite, 1/4 ID x 1/2 inch OD
	210-223			1	LUG, solder, 1/4 inch hole
	210-465			1	NUT, hex, brass, 1/4-32 x 3/8 x 3/32 inch
4	380-063			1	HOUSING, assembly
	211-504			4	Mounting Hardware: (not included) SCREW, 6-32 x 1/4 inch BHS
5	136-150			4	SOCKET, 3 pin transistor for etched ckt board

EXPLODED VIEW (Cont'd)

REF. NO.	PART NO.	SERIAL NO.		QTY.	DESCRIPTION
		EFF.	DISC.		
6	361-069			2	SPACER, heat sink, .125 alum. .625 x .750
	Mounting Hardware: (not included)
	210-909			1	WASHER, mica, silicon, .625 OD x .196 inch ID
	210-803			1	WASHER, steel 6L x 3/8 inch
	210-005			1	LOCKWASHER, steel, ext. #6
	211-510			1	SCREW, 6-32 x 3/8 inch BHS
7	200-562			1	COVER, top
8	333-792			1	PANEL, front
	Mounting Hardware: (not included)
	211-537			4	SCREW, 6-32 x 3/8 inch Truss HS, phillips
9	366-142			1	KNOB, TEST VOLTS, charcoal
	Includes:
	213-004			1	SCREW, set, 6-32 x 3/16 inch HSS
10	366-177			1	KNOB, VARIABLE, red
	Includes:
	213-004			1	SCREW, set, 6-32 x 3/16 inch HSS
11	366-142			1	KNOB, TEST VOLTS, charcoal
	Includes:
	213-004			1	SCREW, set, 6-32 x 3/16 inch HSS
12	366-177			1	KNOB, BIAS CURRENT, red
	Includes:
	213-004			1	SCREW, set, 6-32 x 3/16 inch HSS
13	366-177			1	KNOB, VARIABLE, red
	Includes:
	213-004			1	SCREW, set, 6-32 x 3/16 inch HSS
14	366-142			1	KNOB, BIAS CURRENT, charcoal
	Includes:
	213-004			1	SCREW, set, 6-32 x 3/16 inch HSS
15	384-519			8	RODS, spacing alum., hex, 1/4 x 9/16 inch
	Mounting Hardware: (not included)
	210-005			1	LOCKWASHER, steel ext. #6
	211-510			1	SCREW, 6-32 x 3/8 inch BHS
16	179-872			1	CABLE, harness, transformer
17	343-106			1	CLAMP, steel, .625 x 2.187 x 4.832 inch
	361-070			2	SPACER, transformer, textolite, (not shown)
	Mounting Hardware: (not included)
	212-023			1	SCREW, 8-32 x 3/8 inch BHS
	210-458			1	NUT, keps steel, 8-32 x 11/32 inch
18	367-007			1	HANDLE, drawer
	Mounting Hardware: (not included)
	212-023			2	SCREW, 8-32 x 3/8 inch BHS
19	260-595			1	SWITCH, BIAS CURRENT, unwired
	Mounting Hardware: (not included)
	358-178			1	BUSHING, front panel charcoal
	210-012			1	LOCKWASHER, steel pot, int. 3/8 x 1/2 inch
	210-413			1	NUT, hex, brass, 3/8-32 x 1/2 inch
20	260-597			1	SWITCH, TEST VOLTS, power, unwired
	Mounting Hardware: (not included)
	358-178			1	BUSHING, front panel, charcoal
	210-012			1	LOCKWASHER, steel pot, int. 3/8 x 1/2 inch
	210-413			1	NUT, hex, brass, 3/8-32 x 1/2 inch
21	260-579			1	SWITCH, TEST VOLTS, unwired
	Mounting Hardware: (not included)
	358-178			1	BUSHING, front panel, charcoal
	210-012			1	LOCKWASHER, steel pot, int. 3/8 x 1/2 inch
	210-413			1	NUT, hex, brass, 3/8-32 x 1/2 inch
22	348-003			1	GROMMET, rubber, 3/16 inch
23	343-003			2	CLAMP, cable, 1/4 inch plastic

EXPLODED VIEW (Cont'd)

REF. NO.	PART NO.	SERIAL NO.		QTY.	DESCRIPTION
		EFF.	DISC.		
24	136-167			1	SOCKET, assembly
	Mounting Hardware: (not included)
	380-047			1	HOUSING, pin socket
	211-540			2	SCREW, 6-32 x 1/2 inch Truss HS, phillips
25	210-457			2	NUT, keps steel, 6-32 x 5/16 inch
	179-873			1	CABLE, harness, power
26	134-012			2	PLUG, plated banana, male, twin
27	352-007			1	HOLDER, fuse, littlefuse
	200-582			1	CAP, fuse, black, 3AG
28	348-037			4	FOOT, rubber, black, 1/2 dia. x 3/16 hi. 1/8 inch hole
	Mounting Hardware: (not included)
	211-011			4	SCREW, 4-40 x 5/16 inch BHS
29	200-563			1	COVER, bottom
	Mounting Hardware: (not included)
30	211-510			2	SCREW, 6-32 x 3/8 inch BHS
	TRANSFORMER, Mounting Hardware:
31	211-553			4	SCREW, 6-32 x 1/2 inch RHS phillips
	384-519			4	RODS, spacing, alum. hex 1/4 x 7/16 inch
	380-067			1	HOUSING, wrap-around

ACCESSORIES

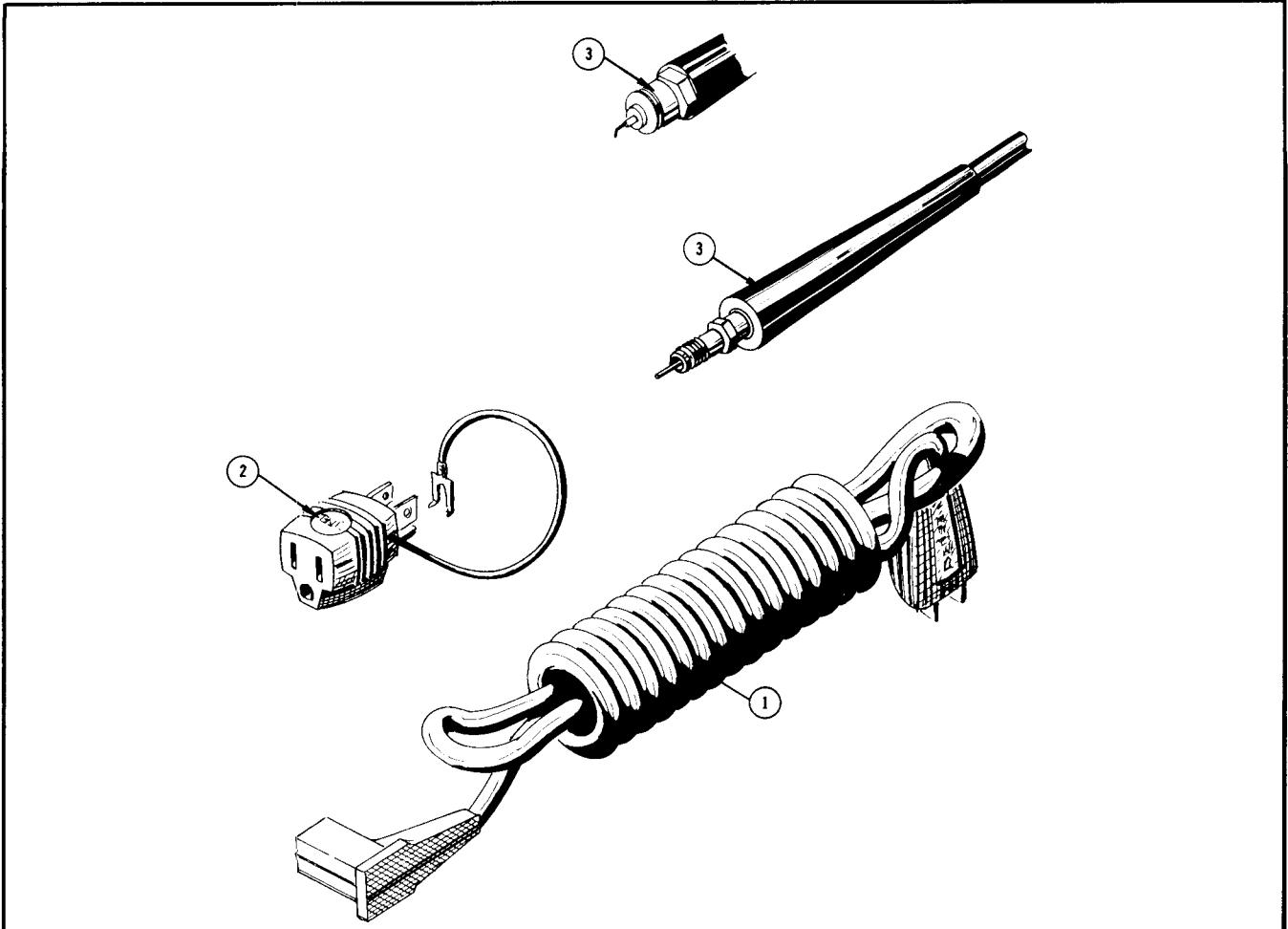

REF. NO.	PART NO.	SERIAL NO.		QTY.	DESCRIPTION
		EFF.	DISC.		
1	161-015			1	CORD, power 20 ga. 8 ft. 3 wire AC
2	103-013			1	ADAPTER, power cord, 3 wire to 2 wire
3	175-269			3	CABLE, UHF, P6040, assembly

CERAMIC STRIPS

3/4 inch



1 notch 124-100



2 notch 124-086



3 notch 124-087

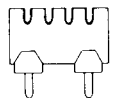

4 notch 124-088

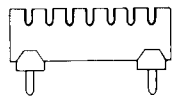

7 notch 124-089

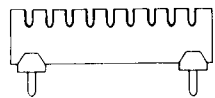

9 notch 124-090

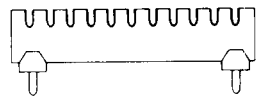

11 notch 124-091

7/16 inch



1 notch 124-118



2 notch 124-119



3 notch 124-092

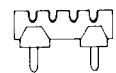

4 notch 124-120

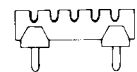

5 notch 124-093

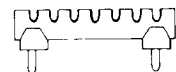

7 notch 124-094



9 notch 124-095

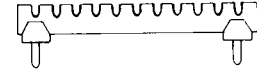

11 notch 124-106

7/16 inch SMALL NOTCH —Short Stud

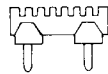

7 notch 124-149

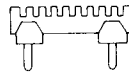

9 notch 124-148

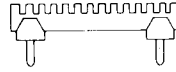

13 notch 124-147

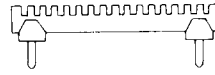

16 notch 124-146

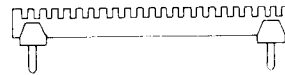

20 notch 124-145

7/16 inch SMALL NOTCH —Tall Stud

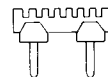

7 notch 124-158

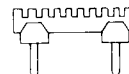

9 notch 124-157

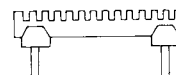

13 notch 124-156

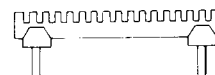

16 notch 124-155

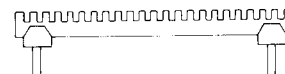

20 notch 124-154

MOUNTINGS



Stud, nylon, short...355-046



Stud, nylon, tall .. 355-082



Spacer, 1¹/₃₂ inch...361-039



Spacer, 3/8 inch .. 361-009



Spacer, 1/4 inch...361-008



Spacer, 5/32 inch...361-007

Ceramic strips include studs, but spacers must be ordered separately by part no.

ELECTRICAL PARTS

Values are fixed unless marked Variable.

Ckt. No.	Tektronix Part No.	Description	S/N Range
----------	--------------------	-------------	-----------

Capacitors

Tolerance $\pm 20\%$ unless otherwise indicated.

Tolerance of all electrolytic capacitors as follows (with exceptions):

3V — 50V = -10% , $+250\%$

51V — 350V = -10% , $+100\%$

351V — 450V = -10% , $+50\%$

C602	283-057	0.1 μ f	Cer	200 v	
C603	290-165	250 μ f	EMT	50 v	
C605	290-165	250 μ f	EMT	50 v	
C622	283-000	0.001 μ f	Cer	500 v	
C624	290-209	50 μ f	EMT	25 v	
C629	283-057	0.1 μ f	Cer	200 v	
C633	283-051	0.0033 μ f	Cer	100 v	5%
C635	283-026	0.2 μ f	Cer	25 v	
C640	283-059	1 μ f	Cer	25 v	
C652	283-057	0.1 μ f	Cer	200 v	
C653	290-165	250 μ f	EMT	50 v	
C655	290-165	250 μ f	EMT	50 v	
C662	281-543	270 pf	Cer	500 v	10%
C663	281-546	330 pf	Cer	500 v	10%
C679	283-059	1 μ f	Cer	25 v	

Diodes

D602	152-107	Silicon, Texas Instruments T160
D612	152-107	Silicon, Texas Instruments T160
D618	152-059	Silicon, Texas Instruments T160
D619	152-107	Silicon, Texas Instruments T160
D620	152-034	Zener 1N753 .4 w, 6.2 v, 10%
D624	152-107	Silicon, Texas Instruments T160
D636	152-107	Silicon, Texas Instruments T160
D637	152-107	Silicon, Texas Instruments T160
D652	152-107	Silicon, Texas Instruments T160
D662	152-107	Silicon, Texas Instruments T160
D666	152-034	Zener 1N753 .4 w, 6.2 v, 10%
D647	152-034	Zener 1N753 .4 w, 6.2 v, 10%

Fuse

F601	159-029	.3 Amp 3AG Slo-Blo 117 v oper.
------	---------	--------------------------------

Parts List—Type 292

Transistors

Ckt. No.	Tektronix Part No.	Description	S/N Range
Q624	*151-103	Replaceable by 2N2219	
Q634	*151-087	Replaceable by 2N1131	
Q637	151-118	2N2339	
Q674	*151-103	Replaceable by 2N2219	
Q684	*151-087	Replaceable by 2N1131	
Q687	151-118	2N2339	

Resistors

Resistors are fixed, composition $\pm 10\%$ unless otherwise indicated.

R603	307-024	2.7 Ω	$\frac{1}{2}$ w			
R605	307-024	2.7 Ω	$\frac{1}{2}$ w			
R613	307-024	2.7 Ω	$\frac{1}{2}$ w			
R615	307-024	2.7 Ω	$\frac{1}{2}$ w			
R616	308-298	560 Ω	$\frac{1}{2}$ w		WW	5%
R617	323-153	383 Ω	$\frac{1}{2}$ w		Prec	1%
R620†	311-446	1 k		Var	VARIABLE	
R622	308-218	150 Ω	3 w		WW	5%
R623	311-442	250 Ω		Var	VOLTS CAL	
R624A	323-062	43.2 Ω	$\frac{1}{2}$ w		Prec	1%
R624B	323-068	49.9 Ω	$\frac{1}{2}$ w		Prec	1%
R624C	323-114	150 Ω	$\frac{1}{2}$ w		Prec	1%
R624D	323-135	249 Ω	$\frac{1}{2}$ w		Prec	1%
R624E	323-164	499 Ω	$\frac{1}{2}$ w		Prec	1%
R629	315-200	20 Ω	$\frac{1}{4}$ w			5%
R631	304-102	1 k	1 w			
R633	308-231	220 Ω	3 w		WW	5%
R634	302-182	1.8 k	$\frac{1}{2}$ w			
R635	315-330	33 Ω	$\frac{1}{4}$ w			5%
R637	307-051	2.7 Ω	$\frac{1}{2}$ w			5%
R653	307-050	5.6 Ω	$\frac{1}{2}$ w			
R656	307-024	2.7 Ω	$\frac{1}{2}$ w			
R655	307-024	2.7 Ω	$\frac{1}{2}$ w			
R666	306-182	1.8 k	2 w			
R672	301-271	270 Ω	$\frac{1}{2}$ w			5%
R674	301-431	430 Ω	$\frac{1}{2}$ w			5%
R676	311-442	250 Ω		Var	CURRENT CAL	
R677††	311-446	1 k		Var	VARIABLE	
R684	302-182	1.8 k	$\frac{1}{2}$ w			
R687A	323-356	49.9 k	$\frac{1}{2}$ w		Prec	1%
R687B	323-327	24.9 k	$\frac{1}{2}$ w		Prec	1%
R687C	323-289	10 k	$\frac{1}{2}$ w		Prec	1%
R687D	323-260	4.99 k	$\frac{1}{2}$ w		Prec	1%
R687E	323-231	2.49 k	$\frac{1}{2}$ w		Prec	1%
R687F	323-193	1 k	$\frac{1}{2}$ w		Prec	1%

† Furnished as a unit with SW620.

†† Furnished as a unit with SW677.

Resistors (Cont'd)

Ckt. No.	Tektronix Part No.		Description		S/N Range
R687G	323-164	499 Ω	1/2 w	Prec	1%
R687H	323-135	249 Ω	1/2 w	Prec	1%
R687J	323-097	100 Ω	1/2 w	Prec	1%
R687K	323-097	100 Ω	1/2 w	Prec	1%
R687L	308-297	24.7 Ω	3 w	WW	1%
R687M	323-097	100 Ω	1/2 w	Prec	1%

Switches

	Unwired	Wired		
SW620††	311-446		Rotary	CALIB
SW624	260-596		Rotary	TEST VOLTS
SW640 }	260-597		Rotary	TEST VOLTS
SW690 }			Rotary	BIAS CURRENT
SW677†††	311-446			CALIB
SW687	260-595		Rotary	BIAS CURRENT mAMPS

Transformer

T601	*120-335	Power
------	----------	-------

† Furnished as a unit with SW620.

† Furnished as a unit with R620.

†† Furnished as a unit with R677.

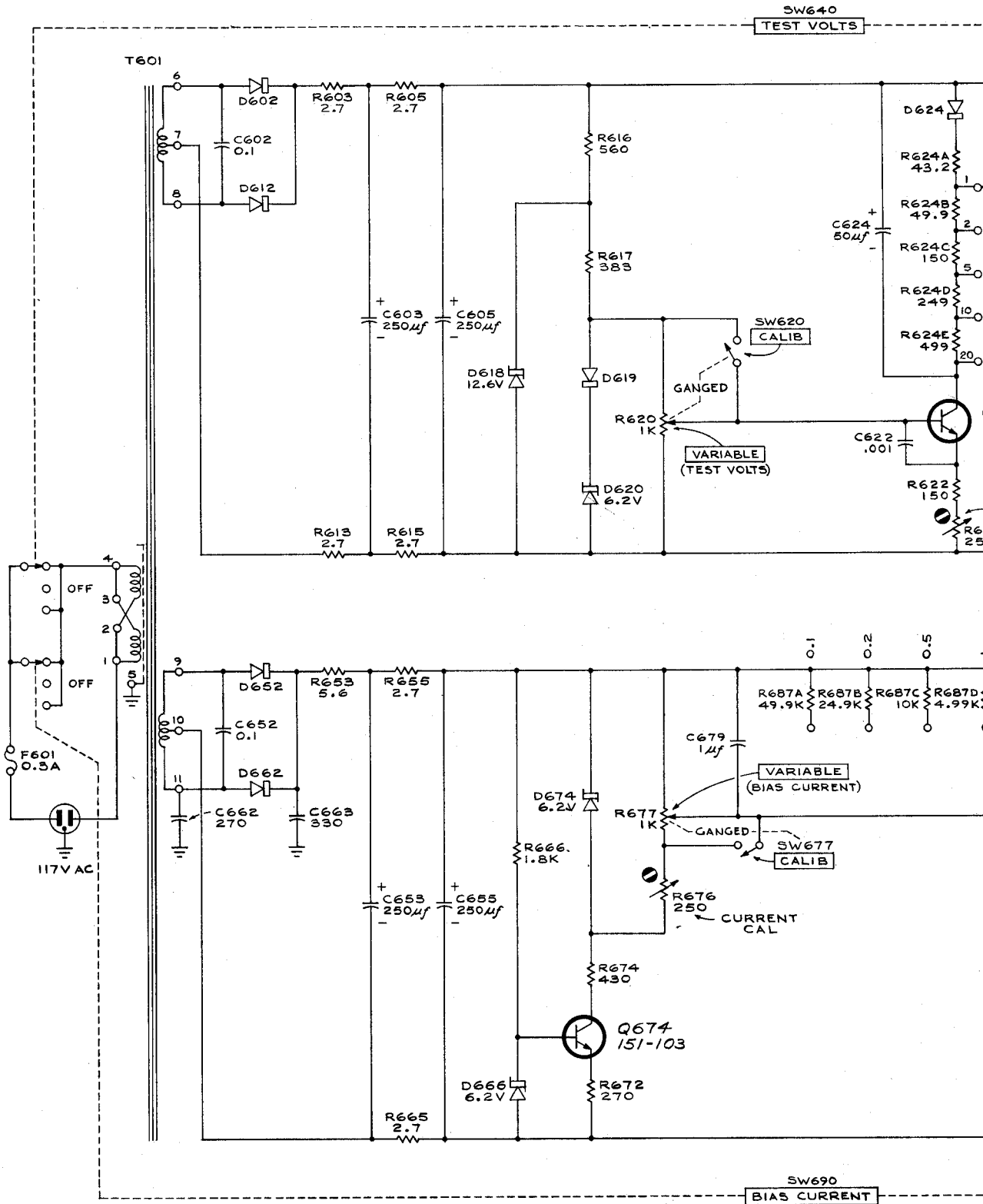

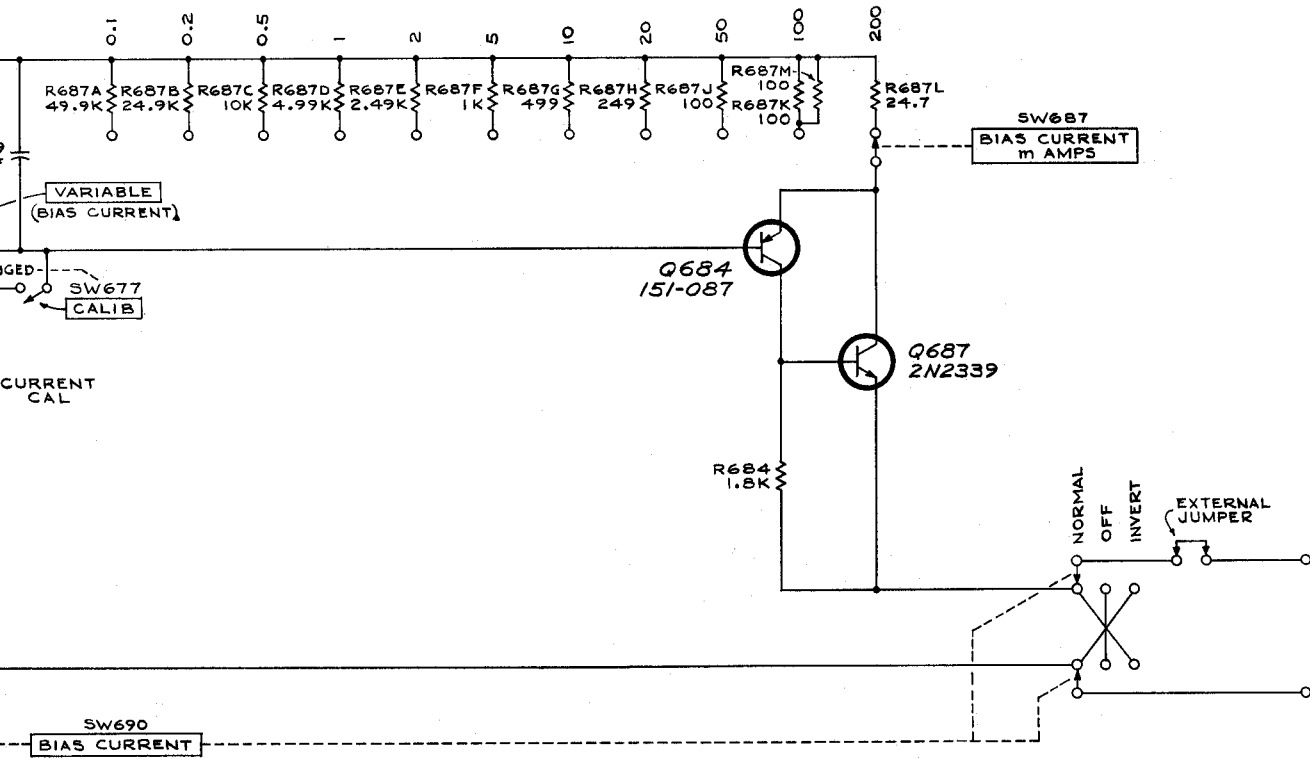
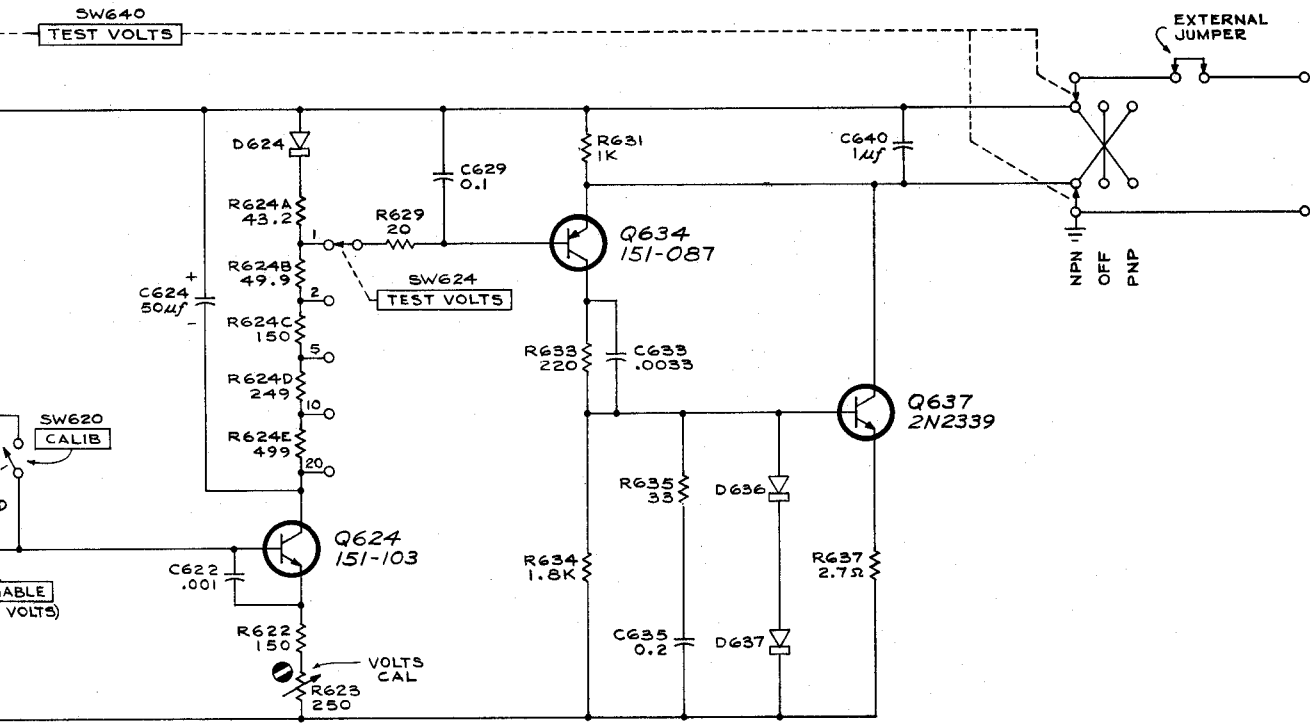

MRH
164

A

SEMICONDUCTOR TESTER POWER SUPPLY

MANUAL CHANGE INFORMATION

At Tektronix, we continually strive to keep up with latest electronic developments by adding circuit and component improvements to our instruments as soon as they are developed and tested.

Sometimes, due to printing and shipping requirements, we can't get these changes immediately into printed manuals. Hence, your manual may contain new change information on following pages. If it does not, your manual is correct as printed.